**User's
Manual**

**PC-Based Measurement Instruments
WE7000
(WE500/WE900)**

Product Registration

Thank you for purchasing YOKOGAWA products.

YOKOGAWA provides registered users with a variety of information and services.

Please allow us to serve you best by completing the product registration form accessible from our homepage.

<http://www.yokogawa.com/tm/>

Thank you for purchasing the YOKOGAWA PC-Based Measurement Instruments, WE7000(WE500/WE900).

This User's Manual contains useful information about the function, installation, wiring, and troubleshooting of the WE7000 measuring station (includes WE7000 Control Software), optical interface module, and optical interface card. To ensure correct use, please read this manual thoroughly before operation.

Keep the manual in a safe place for quick reference in the event a question arises. For information about the handling and operation of each measurement module, see the manual that is provided with the module.

Notes

- **The contents of this manual describe WE7000 Control Software Ver. 5.0.1.0. If you are using another version of the software, the operating procedures or the figures given in this manual may differ from the actual software.**
- The contents of this manual are subject to change without prior notice as a result of continuing improvements to the instrument's performance and functions.
- Every effort has been made in the preparation of this manual to ensure the accuracy of its contents. However, should you have any questions or find any errors, please contact your nearest YOKOGAWA dealer.
- Copying or reproducing all or any part of the contents of this manual without YOKOGAWA's permission is strictly prohibited.

Trademarks

- Microsoft, Windows, and Windows NT are either registered trademarks or trademarks of Microsoft Corporation in the United States and/or other countries.
- Adobe and Acrobat are trademarks of Adobe Systems Incorporated.
- Other product names are trademarks or registered trademarks of their respective holders.

Revisions

1st Edition: June 2004

Checking the Contents of the Package

Unpack the box and check the contents before operating the instrument. If the contents are not correct or missing or if there is physical damage, contact the dealer from which you purchased them. Also, if you are replacing or ordering additional measuring stations, modules, accessories, or parts, make sure to purchase them from the YOKOGAWA dealers.

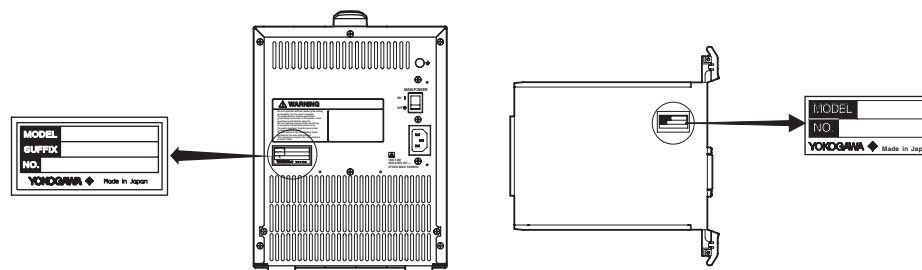

Measuring Stations WE400/WE800

Check that the mode name and suffix code given on the name plate match those on the order.

Model	Suffix Code	Description
707001	-0	WE400 measuring station, with 4 slots
707002	-0	WE800 measuring station, with 8 slots
	-D	UL/CSA standard power cord (Part No.: A1006WD)
	-F	VDE standard power cord (Part No.: A1009WD)
	-Q	BS standard power cord (Part No.: A1054WD)
	-R	AS standard power cord (Part No.: A1024WD)
	-H	GB standard power cord (Part No.: A1064WD) (Complies with the CCC)
	/HE	English Help message

Measurement Modules and Interface Modules

Check that the model name given on the name plate matches those on your order. Also check that the software version is 5.01 or higher (excluding WE7081 and WE7262) (see page 1-3).

Model	Description
707021	WE7021 GP-IB controller module
707081	WE7081 CAN BUS INTERFACE module
707111	WE7111 100 MS/s digital oscilloscope module
707116	WE7116 2-CH, 20 MS/s DigiTaizer module
707121	WE7121 10 MHz function generator module
707131	WE7131 2 MHz pattern I/O module
707141	WE7141 100 MHz universal counter module
707235	WE7235 4-CH, 100 kS/s Accelerometer module
707241	WE7241 10-CH digital thermometer module
707245	WE7245 4-CH, 100 kS/s strain module
707251	WE7251 10-CH, 100 kS/s digitizer module
707262	WE7262 32-Bit digital I/O module
707271	WE7271 4-CH, 100 kS/s isolated digitizer module (screw cramp terminals)
707272	WE7272 4-CH, 100 kS/s isolated digitizer module (BNC terminals)
707273	WE7273 8-CH, 100 kS/s isolated digitizer module (screw cramp terminals)
707275	WE7275 2-CH, 1 MS/s isolated digitizer module
707281	WE7281 4-CH, 100 kS/s D/A module (screw cramp terminals)
707282	WE7282 4-CH, 100 kS/s D/A module (BNC terminals)
707311	WE7311 1 GS/s digital oscilloscope module
707521	WE7521 4-CH timing measurement module

Communication Modules/Cards

Check that the model name and suffix code given on the name plate match those on the order.

Model	Description
707035	WE7035 Optical interface card, for PCs with PCI bus, 1 port
707036	WE7036 Optical interface card, for PCs with PCI bus, 2 ports
707037	WE7037 Optical interface module, for measuring station, 1 port
707038	WE7038 Optical interface module, for measuring station, 2 ports

Standard Accessories

The following standard accessories are supplied with the instrument. Make sure that all items are present and undamaged.

One of these power cords is supplied according to the suffix code.

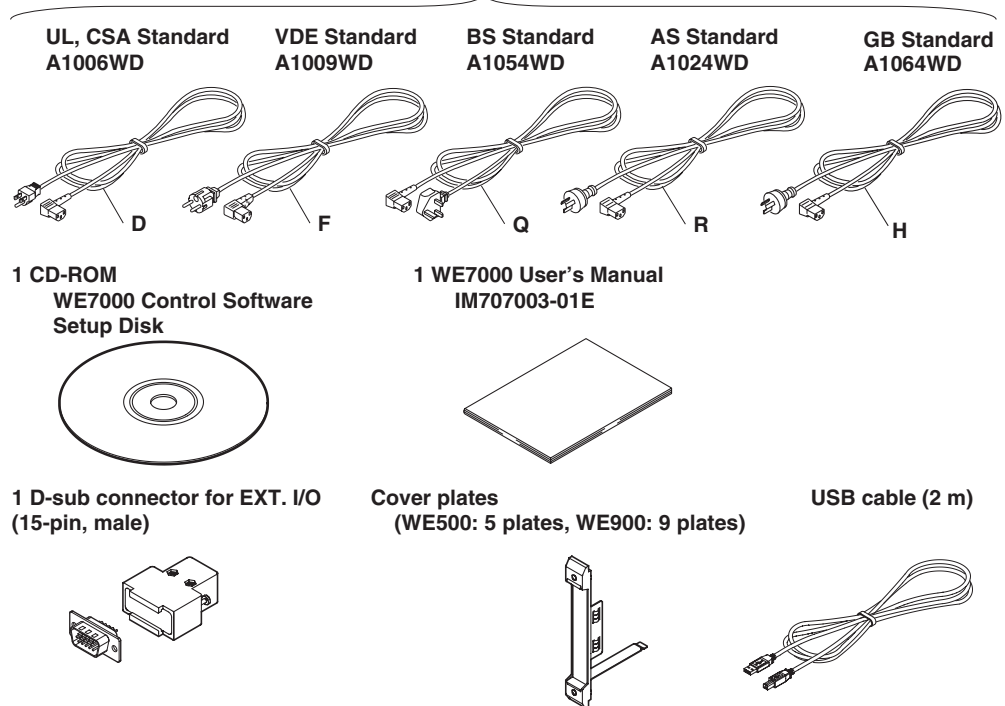

Optional Accessories (Sold Separately)

Name	Model	Description
Pattern I/O probe	707811	for WE7131
30-CH scanner box	707815	for WE7231
Input terminal block	707821	for WE7241/WE7251
16-bit input terminal box	707823	contact input for WE7262
16-bit output terminal box	707824	contact output for WE7262
Optical fiber cable	707831	length: 2 m
Optical fiber cable	707832	length: 5 m
Optical fiber cable	707833	length: 10 m
Optical fiber cable	707834	length: 1 m
Extension connector	707802	for optical fiber cables
Rack mount bracket	707861-J6	for single WE400 measuring station, complies with JIS Standard
Rack mount bracket	707861-E6	for single WE400 measuring station, complies with ANSI/EIA Standard
Rack mount bracket	707862-J6	for multiple WE400 measuring stations, complies with JIS Standard
Rack mount bracket	707862-E6	for multiple WE400 measuring stations, complies with ANSI/EIA Standard
Rack mount bracket	707863-J6	for single WE800 measuring station, complies with JIS Standard
Rack mount bracket	707863-E6	for single WE800 measuring station, complies with ANSI/EIA Standard

Spare Parts for the Measuring Station (Sold Separately)

Name	Model
D-sub connector for EXT I/O interface (15 pins, male)	A1519JD/B8060KA







Software (Sold Separately)

Name	Model	Description
WE7000 Control Software	707701	Same as the standard accessory
Computation Function Setup Software	707702	Software program that adds computation functions to the WE7000 Control Software
Remote Monitor Add-On Software	707703	Software program that adds remote monitor functions to the WE7000 Control Software
WVF File Access API	707712	API for reading and writing in WVF files from VB, VC++, etc.
WVF File Access Toolkit for MATLAB	707713	The toolkit for reading and writing in WVF files from MATLAB
Computation Waveform Viewer	707714	Online software program for the display of WVF files, operation, and analysis.
FFT Viewer	707721	FFT analysis software dedicated to WE7275
Data Viewer Pro for WE	707731	Waveform viewing and file conversion software
WE Control API	707741	Interface for developing dedicated applications
Add On Tool for WE API Vol.1	707742	Interface for developing dedicated applications
Add On Tool for WE API Vol.2	707743	Interface for developing dedicated applications
Control Toolkit for LabVIEW	707746	Interface for developing dedicated applications
Control Toolkit for MATLAB	707747	Interface for developing dedicated applications
Waveform Editor	707751	Waveform editing software

Safety Precautions

This instrument is an IEC safety class I instrument (provided with terminal for protective grounding). The following general safety precautions must be observed during all phases of operation. If the instrument is used in a manner not specified in this manual, the protection provided by the instrument may be impaired. YOKOGAWA Electric Corporation assumes no liability for the customer's failure to comply with these requirements.

The following symbols are used on this instrument.

	To avoid injury, death of personnel or damage to the instrument, the operator must refer to the explanation in the User's Manual or Service Manual.	terminal."
	Function grounding terminal. This terminal should not be used as a "protective grounding	 Alternating current
		 ON (power)
		 OFF (power)
		 Standby

Make sure to comply with the following safety precautions. Not complying might result in injury, death of personnel, or cause damage to the instrument.

WARNING

- **Power Supply**

Ensure that the source voltage matches the voltage of the power supply before turning ON the power.

- **Power Cord and Plug**

To prevent an electric shock or fire, be sure to use the power cord supplied by YOKOGAWA. The main power plug must be plugged into an outlet with a protective grounding terminal. Do not invalidate protection by using an extension cord without protective grounding.

- **Protective Grounding**

Make sure to connect the protective grounding to prevent an electric shock before turning ON the power.

- **Necessity of Protective Grounding**

Never cut off the internal or external protective grounding wire or disconnect the wiring of the protective grounding terminal. Doing so poses a potential shock hazard.

- **Defect of Protective Grounding and Fuse**

Do not operate the instrument when the protective grounding or the fuse might be defective.

- **Do Not Operate in Explosive Atmosphere**

Do not operate the instrument in the presence of flammable liquids or vapors. Operation of any electrical instrument in such an environment constitutes a safety hazard.

- **Do Not Remove Covers**

Some areas inside the instrument have high voltages. Do not remove the cover if the power supply is connected. The cover should be removed by YOKOGAWA's qualified personnel only.

- **External Connection**

To ground securely, connect the protective grounding before connecting to the item under measuring or control unit.

How to Use This Manual

Structure of the Manual

This User's Manual consists of the following six chapters and an index.

Chapter	Title	Description
1	System Configuration	Explains the system configuration of the WE7000 and the names of each part.
2	Installation and Connection	Explains how to install the measuring station, how to install modules and cards, and how to connect optical fiber cables and power cords.
3	Installing the WE7000 Control Software and Starting/Exiting the Program	Explains the installation procedures of the WE7000 Control software, and how to run and exit the program.
4	Operation of the WE7000 Control Software	Explains how to operate the WE7000 Control software.
5	Troubleshooting and Maintenance	Explains procedures for troubleshooting and maintenance.
6	Specifications	Explains the specifications of the measuring station and WE7000 Control software.
Appendix		Explains the optical interface and Web monitor function.
Index		Index of contents.

Conventions Used in This Manual

Unit

k Denotes 1000. Example: 100 kHz

K Denotes 1024. Example: 720 KB

Displayed characters

Alphanumeric characters enclosed with [] usually refer to characters or settings that are displayed on the screen.

Symbols

The following symbol marks are used to attract the operator's attention.



Improper handling or use can lead to injury to the user or damage to the instrument. This symbol appears on the instrument to indicate that the user must refer to the user's manual for special instructions. The same symbol appears in the corresponding place in the user's manual to identify those instructions. In the manual, the symbol is used in conjunction with the word "WARNING" or "CAUTION."

WARNING

Describes precautions that should be observed to prevent serious injury or death to the user.

CAUTION

Describes precautions that should be observed to prevent minor or moderate injury, or damage to the instrument.

Note

Provides important information for the proper operation of the instrument.

WE7000 Document Map

WE7000 User's Manual

- Overall explanation of the configuration and functions of the WE7000
- Installation of the measuring station and the installation of modules
- Connection of the input/output of the measuring station
- Power switch ON/OFF on the measuring station
- Installation procedures of the WE7000 Control Software
- Operations of the WE7000 Control Software
- Overall information about troubleshooting and maintenance of the WE7000
- Specifications of the measuring station/WE7000 Control Software
- Explanation on the optical interface/Web monitor function

User's Manual for Individual Modules

- Explanation on the functions of each module
- Installation procedures for each module
- Connection of the input/output of each module
- Troubleshooting for each module
- Specifications of each module

User's Manual for Utility Software

- Explanation on the functions of each piece of software
- Installation of each piece of software
- Operations of each piece of software
- Specifications of each piece of software

Contents

Checking the Contents of the Package	2
△ Safety Precautions	5
How to Use This Manual	6
WE7000 Document Map	7
Chapter 1 System Configuration	
1.1 About the PC-Based Measurement Instruments WE7000	1-1
1.2 WE7000 System Configuration	1-2
1.3 Names of Parts	1-4
1.4 About the Software for the WE7000	1-5
1.5 About the Trigger Source/Time Base Source/Arming Setting	1-9
Chapter 2 Installation and Connection	
△ 2.1 General Precaution during Installation	2-1
△ 2.2 Installation of the Measuring Station	2-2
△ 2.3 How to Install Modules	2-5
2.4 Connecting to the External Trigger Input Terminal, External I/O and Serial Interface Connector	2-6
△ 2.5 Connecting Interface Cables	2-8
△ 2.6 Connecting the Power Supply and Turning the Power ON/OFF	2-9
Chapter 3 Installing the WE7000 Control Software and Starting/Exiting the Program	
3.1 PC System Requirements	3-1
3.2 Configuring the TCP/IP Settings of the PC	3-2
3.3 Installing the USB Driver	3-4
3.4 Installing the WE7000 Control Software	3-7
3.5 System Configuration when Using Ethernet Communications	3-10
3.6 Configuring Ethernet Communications of the WE7000 Control Software	3-12
3.7 Setting Ethernet Communication via USB	3-13
3.8 Starting and Exiting the WE7000 Control Software	3-15
3.9 Displaying Help	3-17
Chapter 4 Operation of the WE7000 Control Software	
4.1 Turning the Measuring Station ON/OFF and Restarting	4-1
4.2 Changing the Name of Controller/Measuring Station and Entering Comments	4-3
4.3 Menu Bar Operations	4-4
4.4 Station List Window Operations	4-15
4.5 Displaying the Station Window and Operations on the Station Window	4-22
4.6 Setting the Trigger Source/Time Base Source/Arming	4-23
4.7 Displaying the Waveform Monitor and Viewer	4-26
4.8 Saving Waveform Data/Converting Files	4-30
4.9 Assorted Module Binding Function	4-38
Chapter 5 Troubleshooting and Maintenance	
5.1 Troubleshooting	5-1
5.2 Self Test	5-3
5.3 Maintenance	5-4
Chapter 6 Specifications	
6.1 Specifications of the Measuring Station	6-1
6.2 Dimensional Drawings	6-6

Appendix

Appendix 1 Optical Interface App-1
Appendix 2 Displaying Waveforms Using the Web Monitor Function App-9

Index

1

2

3

4

5

6

App

Index

1.1 About the PC-Based Measurement Instruments WE7000

The WE7000 is a new type of PC-based measurement instruments integrating YOKOGAWA's analog, digital, and software technologies. The measuring station capable of holding various measurement modules can be connected to the computer with both the station and the computer can be connected to the Ethernet (10 BASE-T/100BASE-TX) or USB allowing for the construction of a high-speed, multi-channel, diversified measurement system. In addition, the optical interface module and optical interface card that are sold separately can be used to make connections using optical fiber cables (see Appendix 1, "Optical Interface").

Various measurement module sets are available including a digital oscilloscope, a function generator, a counter, and a digitizer which allows measurements from DC to high frequency regions.

Because the insertion and removal of measurement modules and the addition of measuring stations are recognized automatically by plug & play, the system can be easily modified.

Until now, PC-based measurement systems invoked complaints such as: "Writing programs takes too much time," "Transferring of the measured data takes too long for practical use," "Not enough space to combine multiple instruments," and "Wiring is too complicated."

The WE7000 solves these problems and provides a measurement environment which incorporates multimedia.

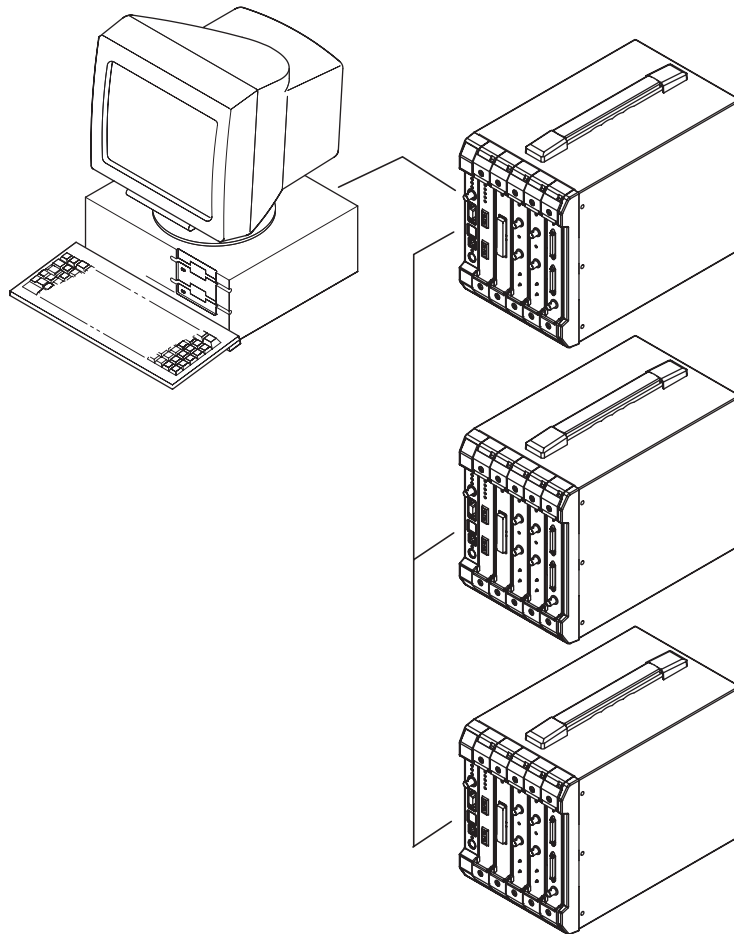

1.2 WE7000 System Configuration

WE7000 Hardware Configuration

The WE7000 is comprised of the following hardware.

Measuring station

The measuring station consists of a case for installing modules, a CPU, a trigger control circuit, a power supply circuit, ethernet interface, USB interface, and a proprietary WE bus. The CPU identifies modules, controls the communication between the module and the PC, and performs data compression. The WE bus is used for transferring synchronous signals generated by a trigger from another module in the same station and also for transferring measured data. You can define two systems of triggers and one system of time base. See section 1.5, "About the Trigger Source/Time Base Source/Arming Settings" for details.

The setup data you set on the PC is transferred from the ethernet interface or USB interface to the measuring station. Signals that enter each measurement module are processed according to the setup data and are output to the WE bus. The output signal from the measurement module is in the form specified by the information in the setup data. Then, the measured data on the WE bus is transferred to the PC through the ethernet interface or USB interface.

In place of the Ethernet or USB port, an optical interface module can be installed for communication with a PC, similar to Ethernet or USB communication, via an optical fiber cable. For a description of optical communication, see Appendix 1, "Optical Interface."

The external input/output connector (EXT. I/O) is used for inputting/outputting trigger and simple DIO, and clock signals as well as outputting the active state signal of the WE bus. The external trigger input connector (TRIG) is used to input external trigger signal.

• When using Ethernet interface

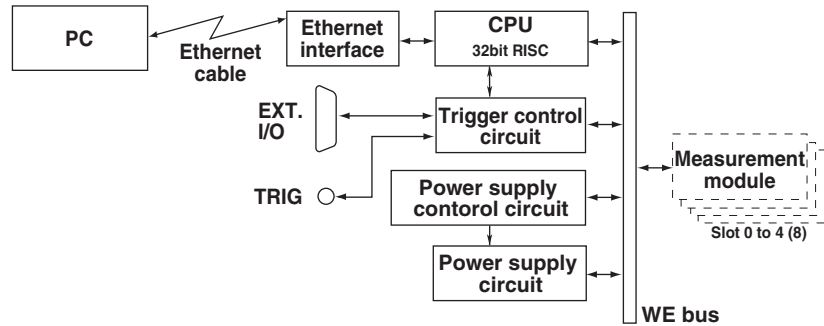

• When using USB interface

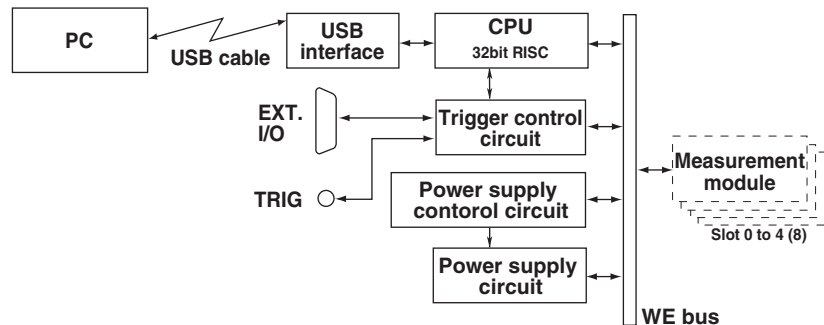

Module

There are two types of modules. One is the measurement module which carries out measurement functions such as a digital oscilloscope or a function generator. The other is the optical communication interface module which is used in the communication between measuring stations and between the measurement module and PC.

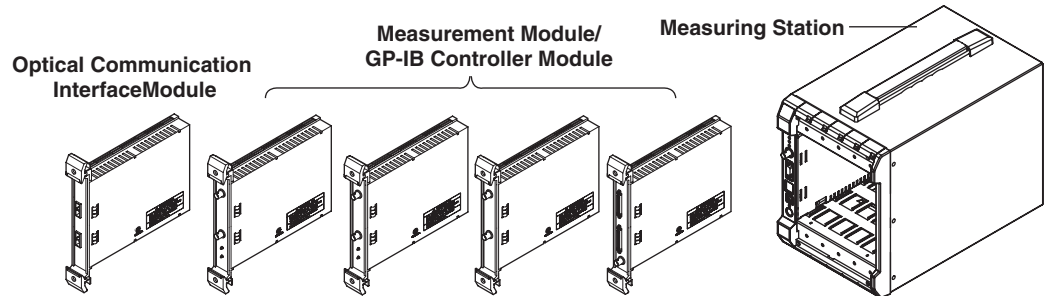
**Note**

- When installing and running the following modules on the WE500/WE900, the module software version must be 5.01 or higher.
WE7021, WE7111, WE7116, WE7121, WE7131, WE7141, WE7231, WE7235, WE7241, WE7245, WE7251, WE7271, WE7272, WE7273, WE7275, WE7281, WE7282, WE7311, and WE7521
- If you are using modules that were used on the WE400/WE800 on the WE500/WE900, check the software version (see page 4-15).
For the upgrade procedure of the module software, contact your nearest YOKOGAWA dealer.

1.3 Names of Parts

Measuring Station

Front Panel

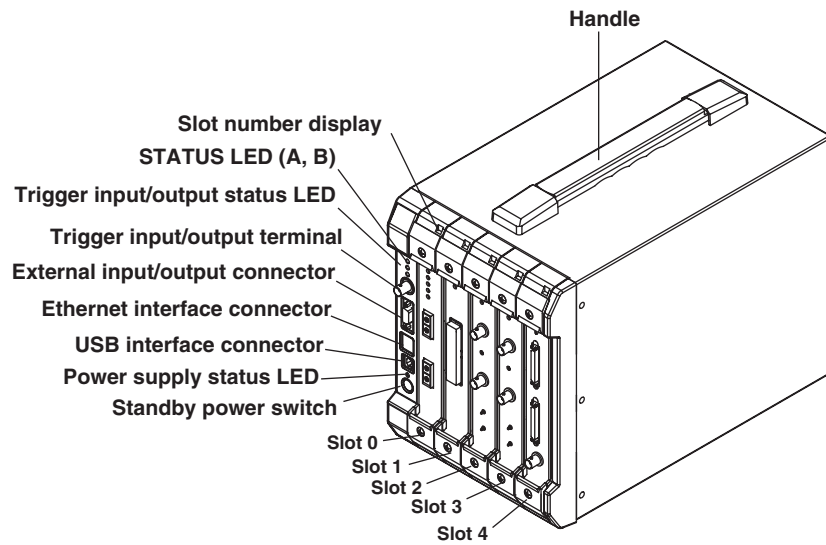

Rear Panel

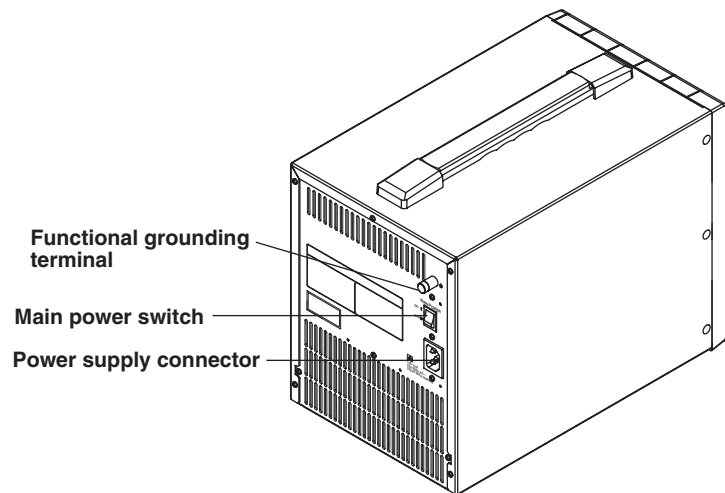

* There is a circuit breaker above the protective grounding terminal on the back panel of the WE900.

1.4 About the Software for the WE7000

The following software applications are provided for use on the WE7000.

WE7000 Control Software

By installing the accessory WE7000 Control Software on the PC, you will be able to control the WE7000 and process the measured data as follows.

- **Turning the Measuring Station ON/OFF**

If the measuring station is in the standby condition, you can turn ON/OFF the power on the measuring station from the PC. However, you cannot do this through the serial interface.

- **Monitoring the Measuring Station's or Measurement Module's Conditions**

If the measuring station is in the standby condition, you can check, in realtime, whether or not each measuring station is connected or whether each station is turned ON/OFF. You can also check whether or not a module is installed on each of the measuring stations.

- **Displaying the Operation Panel of Measurement Modules and Controlling Measurement Operations**

The operation panel of each measurement module is displayed by a click of an icon, and measurement conditions can be set easily using the operation panel. Output conditions from modules that output signals are also set in a similar manner.

Synchronized operation is also possible on modules of the same type. For example, multiple digital oscilloscopes can be linked together and be used to measure multiple channels.

- **Displaying Measured Data**

For modules such as the digital oscilloscope that needs to display the measured waveform, a waveform monitor is displayed. Using the waveform monitor, the many possible activities include: measuring the waveform with the cursor, zooming on the data, saving measured data, and copying the data to the clipboard.

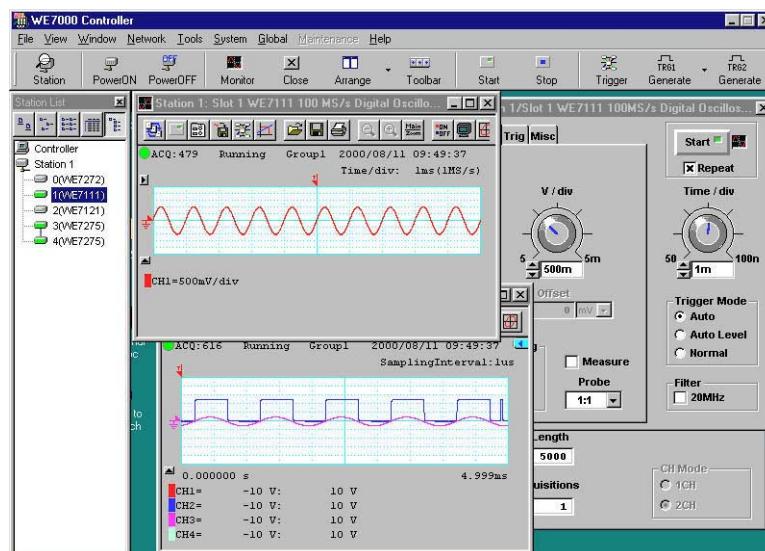

• **Setting Trigger/Time Base Source**

You can easily set the transferring of the trigger signal, time base signal, and arming signal between modules or measuring stations using the setup screen like the one shown below. This function allows control of the measurement operation with the trigger input from other modules or external sources and also allows making measurements by synchronizing multiple modules. These settings are explained in detail in 1.5 “About the Trigger Source/Time Base Source/Arming Settings.”

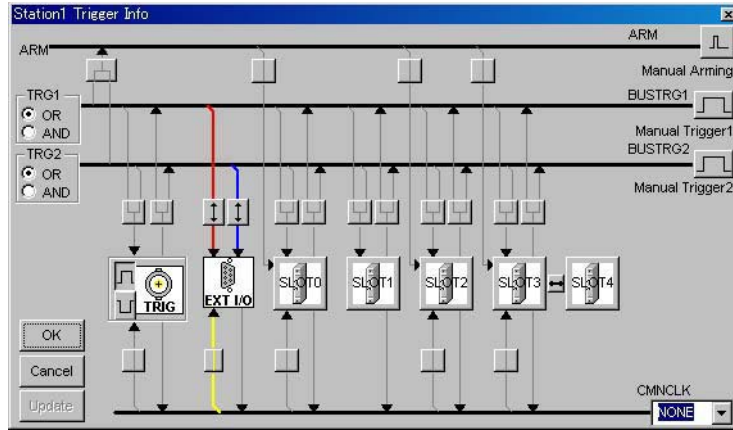

• **Saving/Converting Measured Data**

Besides saving the displayed data on the waveform monitor, you can also automatically save measured data using a trigger signal. Data logging is also possible for data acquisitions with long measurement periods such as temperature measurements. In addition, binary data can be converted to ASCII format (CSV).

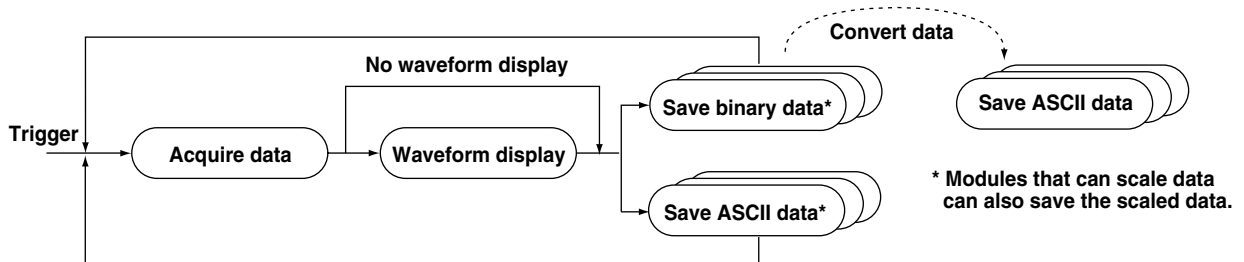

Data Viewer Pro for WE (Software Sold Separately, Model: 707731)

This software is capable of performing various functions such as displaying, computing, file converting, and data linking of the measurement data saved by the WE7000 measurement modules.

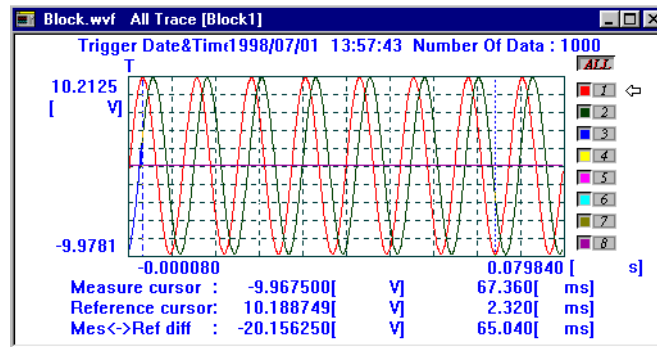

Arbitrary Waveform Editor (Model 707751, software sold separately)

Enables creation of waveform data for loading to modules that can generate arbitrary waveforms such as the D/A module and the function generator module.

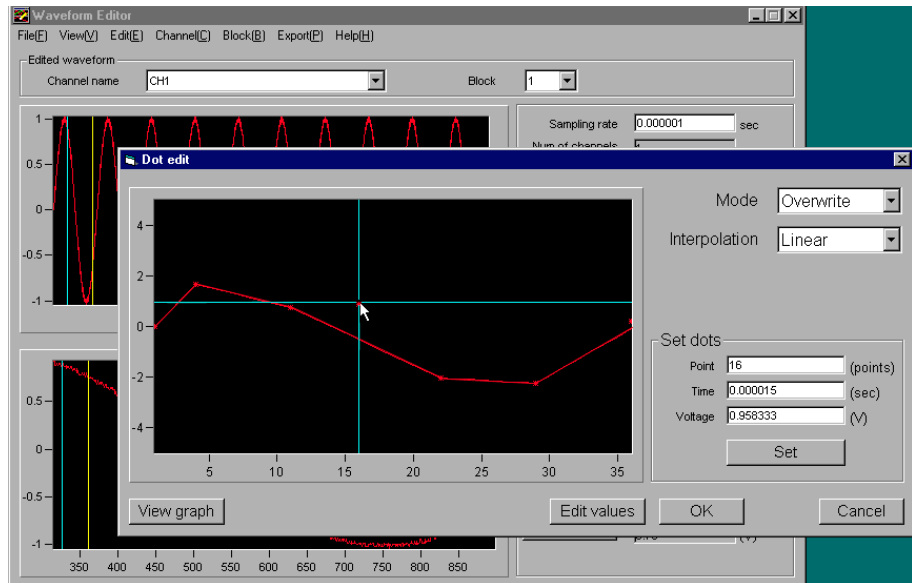
**Computation Function Setup Software (Model 707702, software sold separately)**

This program adds computation functions to the waveform monitor of the WE7000 Control Software. Various types of computations such as four arithmetical operations and FFT as well as averaging can be performed on the acquired waveform data.

Remote Monitor Add-On Software (Model 707703, software sold separately)

Adds a remote monitor function to the WE7000 Control Software. It enables multiple PCs (controllers) existing in the same group on the network to access multiple measuring stations.

FFT Viewer (Model 707721, software sold separately)

Enables real-time FFT analysis of the measured data of the WE7275 2-CH, 1 MS/s Isolated Digitizer Module.

WE Control API (Model 707741, software sold separately)

This is the programming interface that can be used to create software applications that control the WE7000 and process measured data using familiar program development tools for Windows such as Visual Basic and Visual C++. API functions are available for controlling the WE7000.

Waveform Editor (Model 707751, software sold separately)

The Waveform Editor can be used to open preexisting waveform data files, edit the waveform data, and save the resultant data in a specified file format. It can also be used to create new waveform data and save them in a specified file format.

Extension Tool for WE API Vol. 1 (Model 707742, software sold separately)

ActiveX control based on the interface functions (WE Control API) used to control the WE7000. Visual Basic applications can easily be created using the ActiveX controls.

Add On Tool for WE API Vol. 2 (Model 707743, software sold separately)

An ActiveX Control for analyzing the data acquired by the WE7000. You can easily create Visual Basic software applications not only for the WE7000, but also for other types of data.

Control Tool Kit for LabVIEW (Model: 707746, software sold separately)

A tool kit based on the interface functions (WE Control API) used to control the WE7000. The tool kit can be used to easily create software applications for LabVIEW by National Instruments.

Control Tool Kit for MATLAB (Model: 707747, software sold separately)

A tool kit based on the interface functions (WE Control API) used to control the WE7000. The tool kit can be used to create software applications on MATLAB by The MathWorks, Inc.

1.5 About the Trigger Source/Time Base Source/Arming Setting

Bus Trigger Signal and Time Base Signal

Measuring Station WE400/WE800 is equipped with a bus for inputting/outputting two trigger signals (bus trigger signals, BUSTRG1 and BUSTRG2) and one time base signal (CMNCLK) to the I/O terminals on each of the modules and the front panel.

The bus trigger signal is used to provide the timing in acquiring the data. For example, on the 100 MS/s Digital Oscilloscope WE7111, data are acquired before and after the point at which the bus trigger signal becomes “True.” Each measurement module defines its own timing of receiving the bus trigger signal and the operation that is performed when the bus trigger signal becomes “True.” For details on the operation, refer to the User’s Manual for the measurement module.

The time base signal is used to provide the timing for the A/D and D/A sampling and the time for latching the digital signal. The measurement modules that are provided with the time base signal sample the data when the time base signal changes from “False” to “True.”

The bus trigger signal and the time base signal are provided by the following six sources.

1. Measurement module (modules equipped with bus trigger/time base output function).
2. Input signal from the external trigger input terminal (TRIG IN) on the front panel of the measuring station.
3. Input signal from the external input/output connector (EXT. I/O) on the front panel of the measuring station.
4. Communication module that is installed at slot 0 of the measuring station.
5. Clicking the “Generate manual bus trigger” button on the trigger source/time base source setting dialog box (bus trigger only).
6. Selecting “Generate bus trigger signal” in the menu that appears by clicking the right mouse button on the station list window of the WE7000 Control Software (bus trigger only).

You can specify multiple sources for the bus trigger signal. The AND/OR is taken on the multiple source signals to determine the bus trigger signal state. The selection of whether to use the AND or OR, and the selection of the sources for the bus trigger signal are set using the trigger source/time base source setting dialog box (see section 4.6, “Setting the Trigger Source/Time Base Source/Arming”).

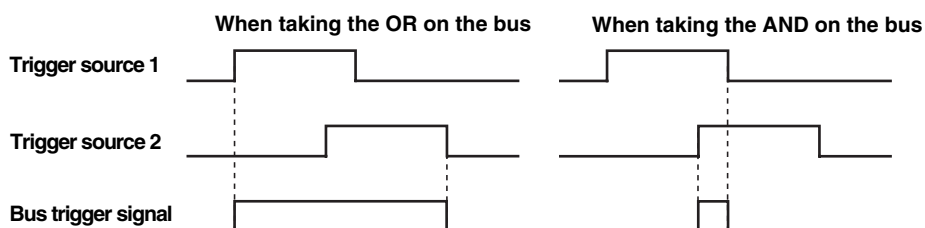

Note

- When taking the AND/OR on multiple trigger signals that change about the same time, a glitch may result on the bus trigger signal. To avoid this, adjust the timing of each of the trigger signals.
- Note that the trigger signal that is generated by clicking the generate manual trigger button in the trigger source/time base source setting dialog box is one of the bus trigger signal sources. Therefore, if you selected AND computation, you must turn this button ON and generate the trigger signal on the bus in order for the bus trigger to become “True.”

One source from source 1 to 4 given above can be output as the time base signal. If there are several modules that can provide the time base signal, only one is used. The time base signal source is also set in the trigger source/time base source setting dialog box (see section 4.6, “Setting the Trigger Source/Time Base Source/Arming”).

Trigger/Time Base Signal Input/Output of the Measurement Module

When using a measurement module equipped with a trigger/time base input/output function, the bus trigger signal and time base signal can be input/output from the measurement module by using the trigger source/time base source setting dialog box. A bus trigger signal can be passed to another measurement module with the detection of an internal trigger. The bus trigger signal, then can be used to trigger the other measurement module. You can also output the internal time base signal of a measurement module to the bus, or operate a measurement module according to the time base signal.

Please note that a module will not start detecting the bus trigger just by setting the module to input the bus trigger signal in the trigger source/time base source setting dialog box. Make sure to select [BUSTRG] for the [Source] setting in the operation panel of the measurement module (see section 4.6, "Setting the Trigger Source/Time Base Source/Arming").

Similarly, a measurement module will not start using the time base signal just by setting the module to input the time base signal in the trigger source/time base source setting dialog box. Make sure to select [BUSCLK] for the [Time Base] setting (the name maybe different on different modules) on the operation panel (see section 4.6, "Setting the Trigger Source/Time Base Source/Arming").

If you set the bus trigger signal/time base signal to be output to the bus in the trigger source/time base source setting dialog box, the trigger/time base signal generated in the module is output to the bus. For the timings of the trigger/time base signal, see the manual of the measurement module.

You can use the trigger/time base signal input/output function to synchronize the trigger timings among measurement modules of different type, and perform synchronized sampling operation. For example, you can have the 32-Bit Pattern I/O Module WE7131 output a bus trigger signal upon detecting a pattern match in the digital input, and the 100 MS/s Digital Oscilloscope Module WE7111 can use the trigger signal to measure the signal around the pattern matching point. As another example, you can use the 10 MHz Function Generator Module WE7121 to generate a 10.24-kHz time base signal, and the 10-CH, 100 kS/s Digitizer Module WE7251 can synchronize to that signal to perform A/D conversion.

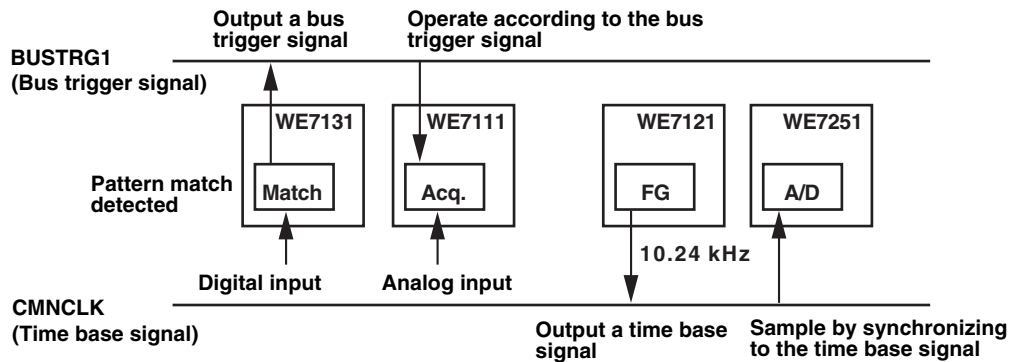

Some measurement modules can output a bus trigger signal upon detecting a trigger within the module, and receive the results of the AND/OR computation on the bus to trigger the actual trigger operation. When using the module in this way, set the connection between the module and the bus trigger source to "input and output" in the trigger source/time base source setting dialog box.

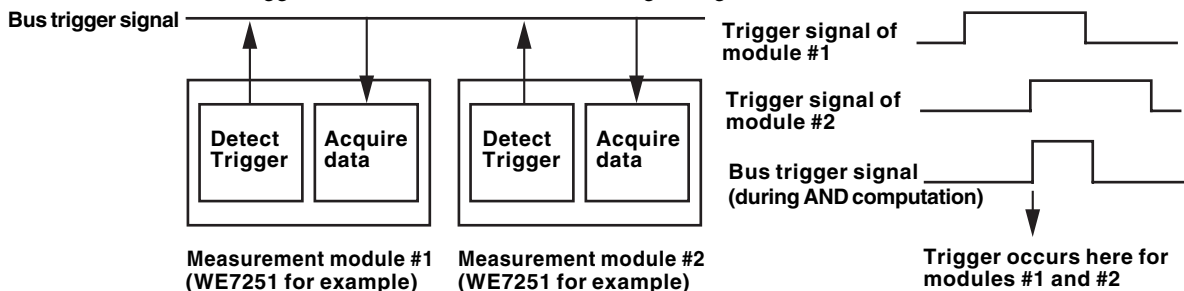

Note

When the frequency of the internal time base signal of a measurement module is above 10 MHz, the system may not operate properly if this signal is output to the bus. Make sure the frequency of the time base signal that is output to the bus is below 10 MHz.

Input from the Trigger Input/Output Terminal (TRIG)**Input**

You can use the external trigger input terminal (TRIG) to input external bus trigger signals and time base signals. For example, a measurement module can be triggered by synchronizing to a trigger signal from an external device.

The input signal is a CMOS level signal and the polarity can be selected. The delay time between the external trigger input (TRIG) and the internal station trigger signal is as follows:

External trigger input (TRIG) → bus trigger signal: 40 ns (typical value*)

External trigger input (TRIG) → time base signal: 35 ns (typical value*)

* Typical values represents typical or average values. They are not strictly guaranteed.

The pulse width of the external bus trigger signal must at least be 100 ns (or 50 μ s when using it as an arming source). The pulse width of the external time base signal must at least be 100 ns, and the frequency must be 5 MHz or below.

Output

Either the bus trigger signal or time base signal of the measuring station can be output using the trigger input/output terminal (TRIG). The input signal is CMOS level, and the polarity is selectable.

Note that when outputting the bus trigger signal, the pulse width of the output waveform varies depending on the bus trigger computation setting. If an AND operation is performed on the bus, the bus trigger signal may be an extremely short pulse (see page 1-9). Likewise, if the time during which the trigger is false is short in an OR operation, the false bus trigger signal may not be output accurately.

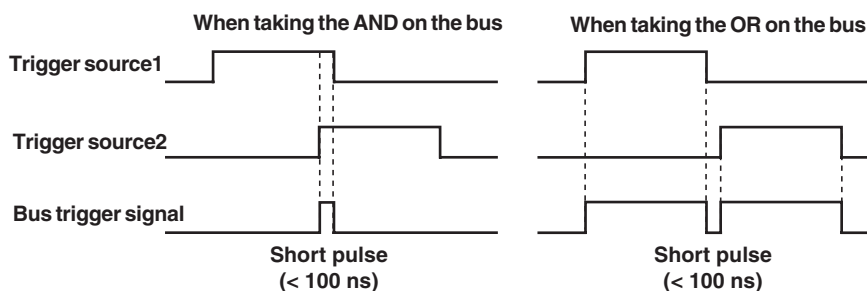

Note that these phenomena also hold true for trigger output from the EXT. I/O connector explained on the next page.

If the trigger input/output terminal (TRIG) is set to output, the trigger input/output status LED illuminates in green.

Input/Output from the External Input/Output Connector (EXT. I/O)

By using the external input/output connector (EXT. I/O), you can input bus trigger signals and time base signals from outside the measuring station and visa versa. You can select whether to input or output a signal from the external input/output connector (EXT. I/O) in the trigger source/time base source setting dialog box.

When inputting/outputting a bus trigger signal from the external input/output connector (EXT. I/O), the polarity of the signal varies depending on whether the measuring station is taking the AND or OR of the bus trigger signals. When taking the AND, the trigger within the measuring station becomes “True” when the external signal is low. Conversely, when taking the OR, the trigger within the measuring station becomes “True” when the external signal is high. When inputting/outputting a time base signal, the time base signal within the station becomes “True” when the external signal is high. Therefore, sampling will occur on the rising edge of the external signal.

The delay time when inputting a bus trigger signal from the external input/output connector (EXT.I/O) is approximately 25 ns (typical value*). The delay time when inputting a time base signal is approximately 10 ns (typical value*). In addition, the delay time when outputting a bus trigger signal or a time base signal to the external input/output connector (EXT. I/O) is approximately 25 ns (typical value*).

* Typical values represents typical or average values. They are not strictly guaranteed.

As in the trigger input/output terminal, the pulse width of the external bus trigger signal must be at least 100 ns (or 50 ms when using it as an arming source). The pulse width of the external time base signal must at least be 100 ns, and the frequency must be 5 MHz or less.

By outputting the bus trigger signal/time base signal from the external input/output connector (EXT. I/O) of one measuring station and inputting it to another station, you can synchronize multiple measuring stations.

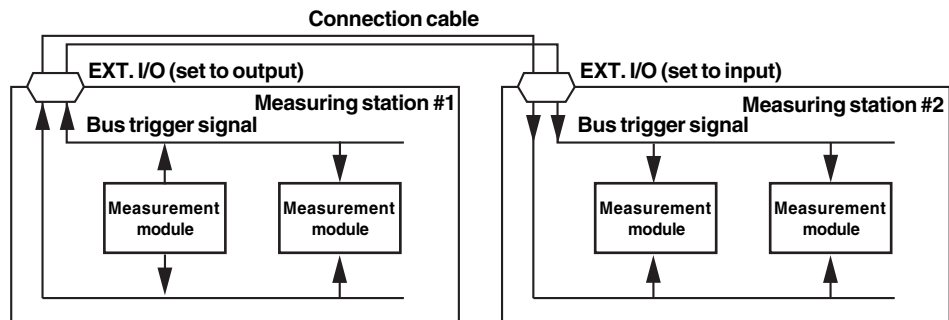

In such connections, there is an output impedance of approximately 100 Ω at the external input/output connector (EXT. I/O). Thus, using a long connection cable can deteriorate the waveform due to noise and capacity of the cable. This, in turn, can cause long delays and improper operation. Therefore, make sure to use a shielded cable and keep the length of the cable under two meters.

Arming Signal

An arming signal is provided so that multiple measurement modules that are installed in the measuring station can start their measurements simultaneously. To use the arming signal, connect the arming signal (ARM) bus and the measurement modules in the trigger source/time base source setting dialog box.

The measurement modules that are connected to the arming signal bus enter the arming signal wait state when the [Start] button on the module's operation panel is clicked. Measurements start when the arming signal becomes [True]. If [Repeat] of the [Start] button is checked, the module enters the arming signal wait state after each measurement. For example, if the 100 MS/s digital oscilloscope module WE7111 is connected to the arming signal bus and the [Repeat] box is checked, the module enters the arming signal wait state every time it acquires the waveform once.

In order to start multiple modules simultaneously, connect each module to the arming signal, click the [Start] button on the operation panel to enter the arming signal wait state, and set the arming signal to [True]. The difference in the start times between modules is 10 ms or less.

The arming signal is provided by the following three sources.

1. Bus trigger signal (BUSTRG1 or BUSTRG2)
2. Clicking the "Manual Arming" button on the trigger source/time base source setting dialog box (bus trigger only).
3. Selecting [Generate Arming Signal] in the menu that appears by clicking the right mouse button on the stationlist window of the WE7000 Control Software (bus trigger only).

Use the trigger source/time base source setting dialog box to set the bus trigger signal for the arming signal's source.

You can generate an arming signal across multiple measuring stations almost simultaneously (10 ms or less between stations) by selecting the station icons in the station list window of the WE7000 Control Software and then generating the arming signal by selecting [Generate Arming Signal] in the menu that appears by clicking the right mouse button.

By assigning the bus trigger signal to be the arming signal's source, you can start multiple modules simultaneously using an external trigger signal thereby collecting data synchronously.

For example, you can take the following steps to start the measurement modules simultaneously.

1. Input a bus trigger signal (BUSTRG1) through the TRIG input
2. Set the arming signal's source to bus trigger signal (BUSTRG1)
3. Connect the modules that you wish to start simultaneously to the arming signal bus. Click the [Start] button on each module to enter the arming signal wait state and apply the trigger signal from the TRIG input. The measurement modules simultaneously start data acquisition. The same operation can also be carried out by selecting [Start all armed modules] from the station menu (see section 4.6, "Setting the Trigger Source/Time Base Source/Arming").

By using the arming signal, you can synchronize the modules even when there are no trigger inputs such as when using the 10-CH digital thermometer module WE7241 or when using the 10-CH, 100 kS/s digitizer module WE7251 in the free run mode.

Note

When using bus trigger signal as an arming source, the pulse width of the bus trigger signal must be at least 50 μ s.

2.1 General Precaution during Installation

△ Safety Precautions

- Make sure to read the safety precautions described on page 5 before using the instrument for the first time.
- Do not remove any covers from the instrument
For internal inspection or adjustment, contact your nearest YOKOGAWA dealer.
- Malfunction
Never continue to use the instrument if there are any symptoms of trouble such as unusual sounds, strange smells or smoke coming from the instrument. In such cases, immediately turn OFF the power and unplug the power cord. When using an adapter for direct wiring to the power supply, immediately cut off the power supply. Also disconnect the power to the equipment under measurement. Then, contact your nearest YOKOGAWA dealer.
- Power Cord
Nothing should be placed on the power cord; it should also be kept away from any heat sources. When unplugging the power cord from the outlet, never pull the cord itself. Always hold the plug and pull it. If the power cord is damaged, contact your dealer for replacement. Refer to page 2 for the part number when placing an order.

△ General Handling Precautions

- Never place anything on top of the instrument.
Never place another instrument or any objects containing water on top of the instrument. This may cause problems.
- When moving the instrument
First, turn off the power of the equipment being measured and disconnect the measurement leadwires and the interface cable. Then, turn OFF the main power switch of the measuring station and unplug the power cord from the outlet. When carrying the instrument, securely hold the handle of the measuring station.
An 9-slot measuring station filled with modules can weigh from approx. 11 to 20 kg. To avoid injury, have someone help you carry it.
- Electrically charged objects
Do not bring electrically charged objects near the input terminals. The internal circuitry could be damaged.
- Chemicals
Do not pour volatile agents on the case nor leave the case in contact with rubber or PVC products for long periods of time. The case is made of a thermoplastic resin, so take care not to let anything hot such as a soldering iron touch the case.
- Cleaning
When cleaning the case or any other part of the measuring station, first remove the power cord from the outlet (and in case of direct connection, disconnect the power lines). Do not use volatile chemicals since this might cause discoloring and deformation. Always use a dry, soft cloth for cleaning.
- When not using the instrument for a long time
When the instrument is not being used for an extended period of time, unplug the power cord from the outlet (when using an adapter for direct wiring to the power supply, disconnect the power cord from the outlet).

2.2 Installation of the Measuring Station

Installation Conditions



WARNING

- Do not use the measuring station with the rear side down. Objects falling from the vent holes on the rear panel may cause fire when malfunction occurs.

The instrument must be installed in a location where the following conditions are met.

- Ambient temperature: 5 to 40°C
- Ambient humidity: 20 to 80% RH (However, maximum wet bulb temperature of 29°C and no condensation should be present.)

Note

Internal condensation may occur if the instrument is moved to another place where both the ambient temperature and humidity are higher, or if the temperature changes rapidly.

Well-ventilated Location

To avoid internal overheating, do not obstruct the vent holes on the top, rear, and bottom sides of the instrument. Leave at least 10 cm of space around the top and rear sides of the instrument.

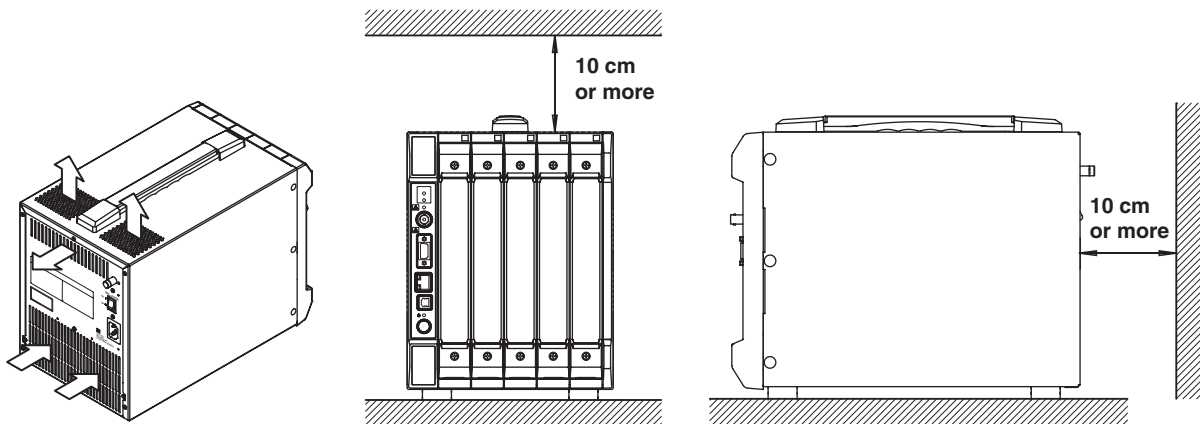

Never install the instrument in any of the following locations:

- In direct sunlight or near heat sources.
- Where an excessive amount of soot, steam, dust or corrosive gases are present.
- Near strong magnetic field sources.
- Near high voltage equipment or power lines.
- Where the level of mechanical vibrations is high.
- In an unstable place.

Installation Method

Desktop or floor installation

Install the instrument on a horizontal surface such as on a desktop or floor.

Rack mount installation

The following brackets can be purchased for rack mounting

Name	Model	Description
Rack mount bracket	707861-J6	for single WE500 measuring station, complies with JIS Standard
Rack mount bracket	707861-E6	for single WE500 measuring station, complies with ANSI/EIA Standard
Rack mount bracket	707862-J6	for multiple WE500 measuring stations, complies with JIS Standard
Rack mount bracket	707862-E6	for multiple WE500 measuring stations, complies with ANSI/EIA Standard
Rack mount bracket	707863-J6	for single WE900 measuring station, complies with JIS Standard
Rack mount bracket	707863-E6	for single WE900 measuring station, complies with ANSI/EIA Standard

Mount the measuring station to the rack according to the following installation dimensions (unit: mm).

- For single WE500 measuring station, complying with JIS Standard

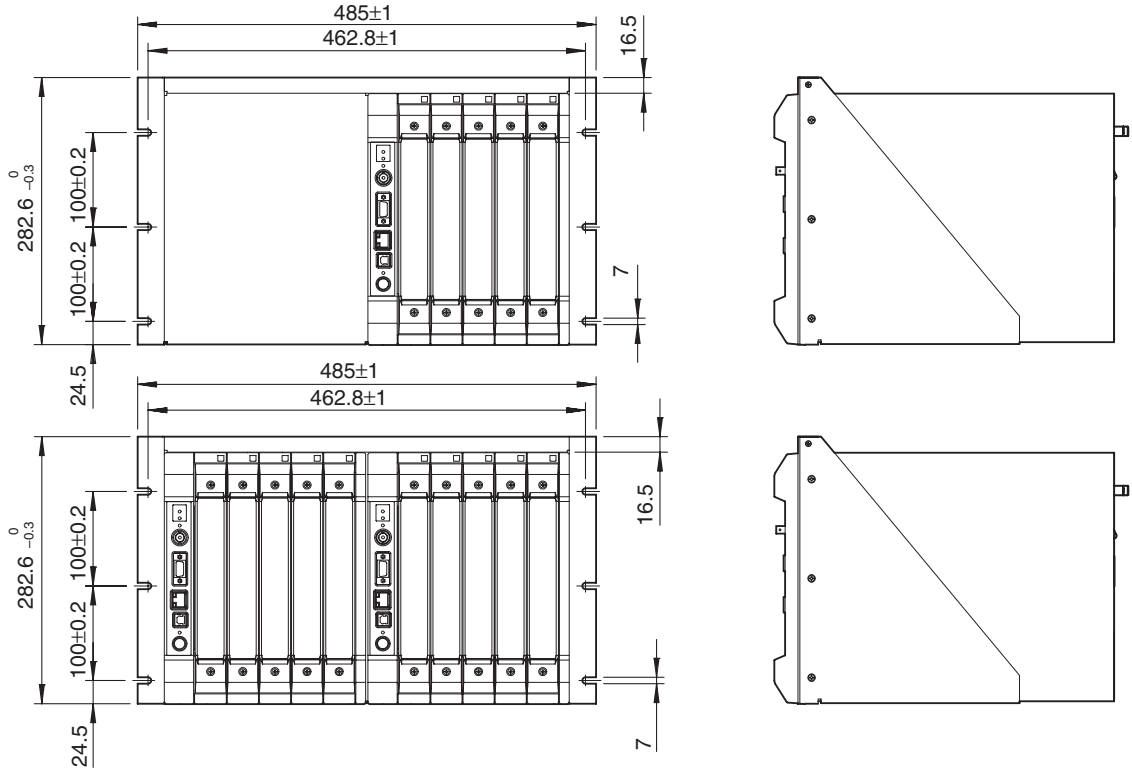

- For single WE500 measuring station, complying with ANSI/EIA Standard

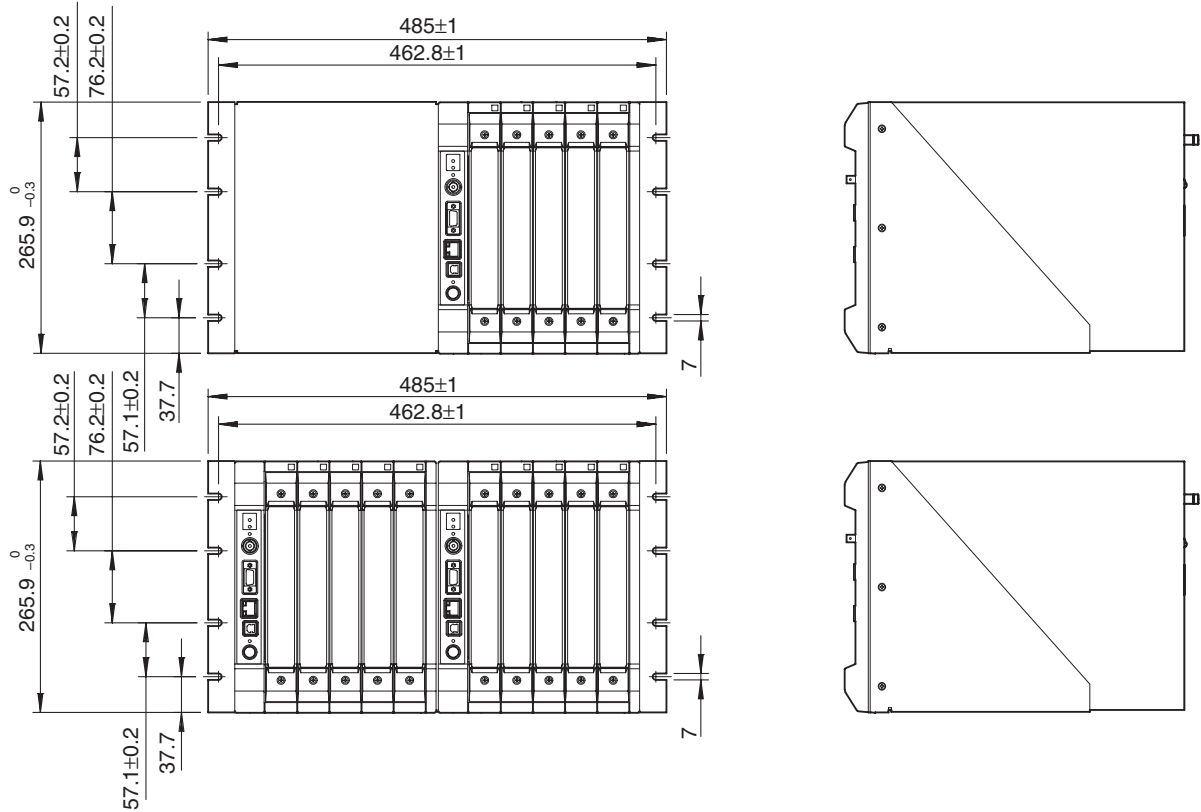

2.2 Installation of the Measuring Station

- For single WE900 measuring station, complying with JIS Standard

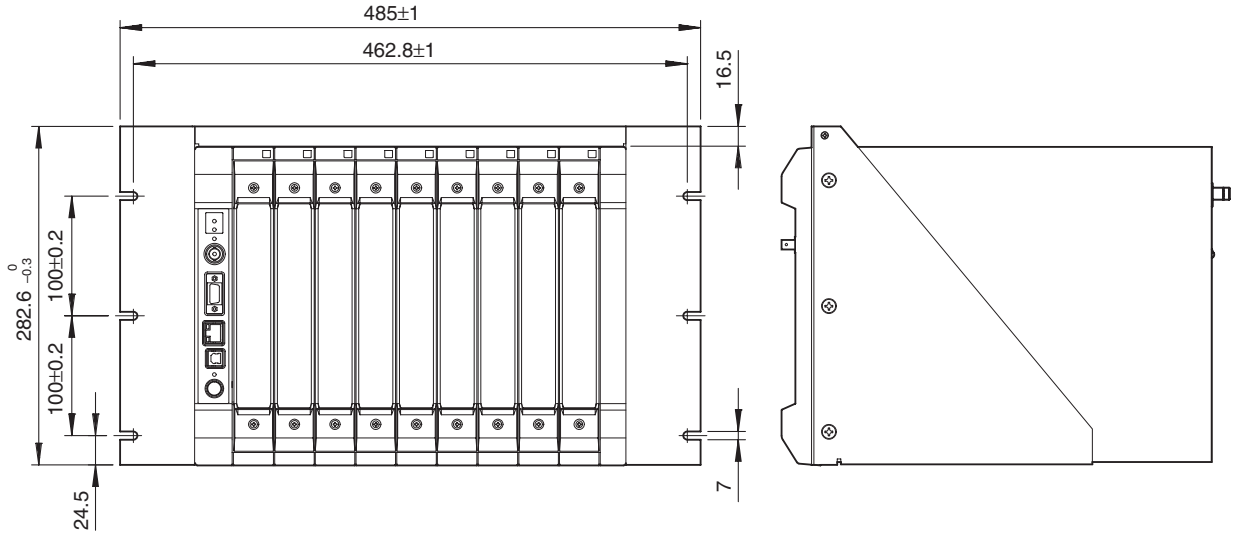

- For single WE900 measuring station, complying with ANSI/EIA Standard

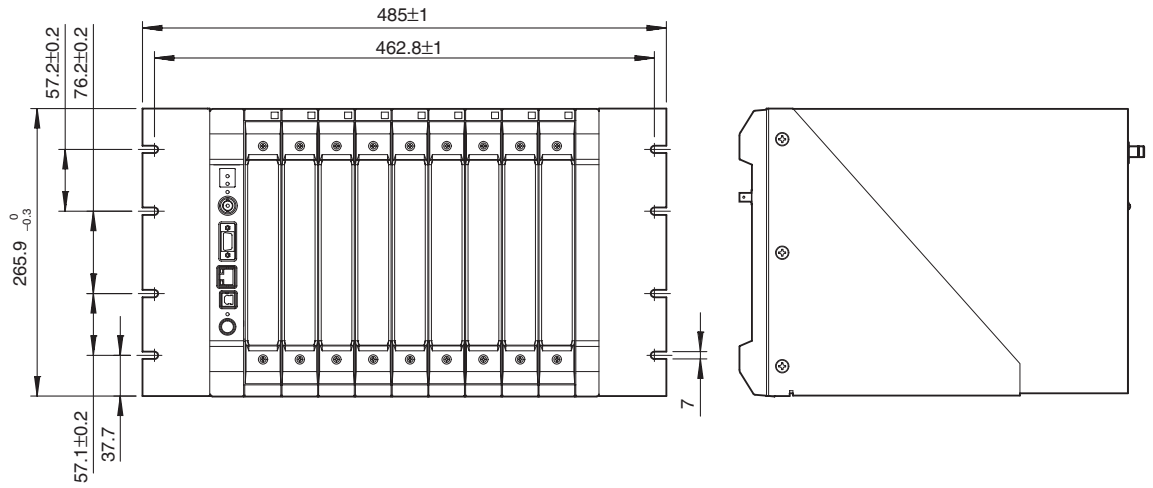

2.3 How to Install Modules



WARNING

- Make sure to fasten the top and bottom attachment screws of the module. If you connect the input signal cable without fastening the attachment screws, the protective grounding (see page 2-9) provided by the power cord is compromised and may cause electric shock.



CAUTION

- To avoid damaging the instrument when installing modules, make sure to turn OFF the power switch of the measuring station according to the installing method given below.
- Be careful not to get your fingers caught in the eject lever when installing the module. Also, do not put your hand inside the slot, because you may injure your fingers on protrusions.
- Do not remove the cover plates from the empty slots. Doing so will cause overheating and malfunction. The cover plates are also needed to reduce electro-magnetic interference.

Installation Method

1. Verify that the power supply is not connected to the measuring station or the standby power switch or the main power switch is turned OFF.
When installing an optical interface module into slot 0, make sure to turn OFF the main power switch (see page 2-10) on the rear panel. Measurement modules can be installed by turning OFF just the standby power switch (see page 2-11) on the front panel.
2. Remove the cover plate from the slot where the module is to be installed.
3. Insert the module in the slot. Press firmly until it is securely connected to the connector.
4. Fasten the two locations (top and bottom) of the module with the attachment M3 screws.

Set the tightening torque to 0.6 to 0.7 N·m.

When removing the module, unfasten the screws and open the eject lever as shown in the figure on the lower right.

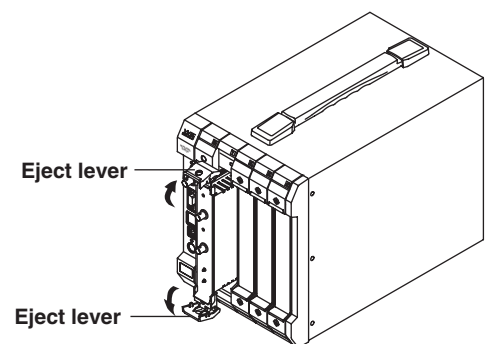
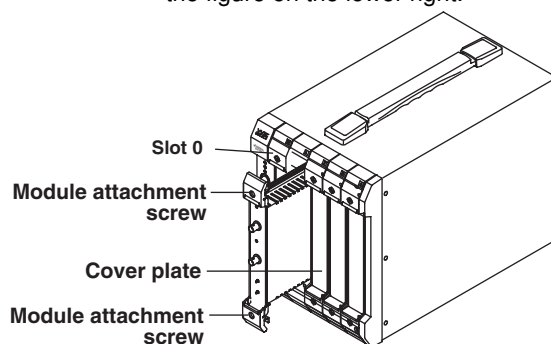

Note

- The optical interface module must be installed into slot 0 (left end). It will not operate properly in other slots.
- When linking the same type of modules (for example, two digital oscilloscope modules for two channel input), install them in adjacent slots.

2.4 Connecting to the External Trigger Input Terminal, External I/O and Serial Interface Connector



CAUTION

- Applying a voltage exceeding the maximum input voltage to any of the input and output terminals may damage the input/output section.

Note

To reduce the effects of electro-magnetic interference, use shielded cables to connect to each of the input and output terminals. If you are connecting the accessory “D-sub connector for EXT. I/O” to the external I/O connector, connect the cable shield to the connector housing.

Terminal/Connector Location

Terminals and connectors are located on the left of the front side of the measuring station as shown in the figure below.

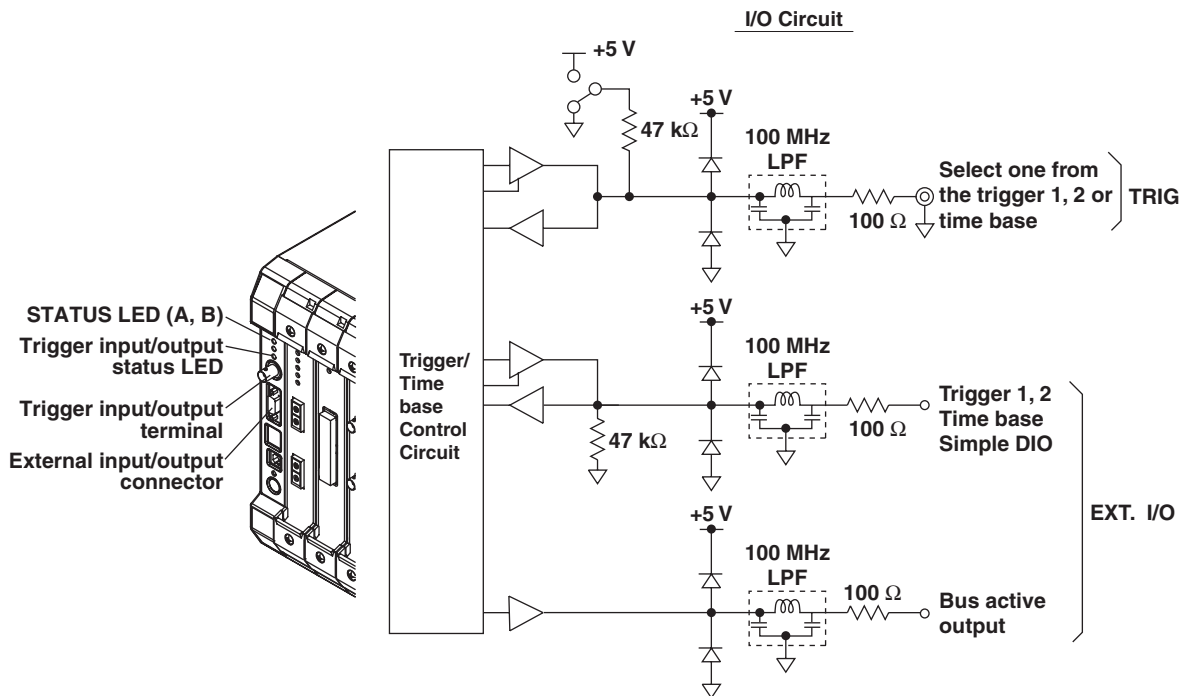

Connecting to the Trigger Input/Output Terminal (TRIG)

The trigger input/output terminal is used when triggering the measurement operation of the measurement module with an external trigger signal. Connect the BNC cable according to the following specification and input/output the trigger signal*.

If the trigger input/output terminal (TRIG) is set to output, the trigger input/output status LED illuminates in green.

Input Specifications

Item	Specification
Connector type	BNC
Pulse width	100 ns or more (or 50 ms or more as an arming source)
Detection edge	Switch rising/falling
Input impedance	Approx. 47 kΩ
Input level	CMOS level
Maximum allowable input voltage	-3 V to +8 V (Overvoltage category CAT I and II)
Output impedance	Approx. 100 Ω
Maximum output current	±3.2 mA

* Able to connect to the WE bus for trigger signal (BUSTRG1/BUSTRG2) or time base signal (CMNCLK).

Connecting to the External Input/Output Connector (EXT. I/O)

The EXT. I/O connector can be used to input and output the trigger, time base, event output, and bus active signals. Use the accessory “D-sub connector for EXT. I/O.”

Pin Assignments

Pin No.	Signal	Pin No.	Signal
1	– (Do not connect)	9	CMNCLK
2	– (Do not connect)	10	GND
3	N.C.	11	BUSTRG1
4	DIO0	12	BUSTRG2
5	DIO1	13	N.C.
6	DIO2	14	GND
7	DIO3	15	Bus active output
8	GND		

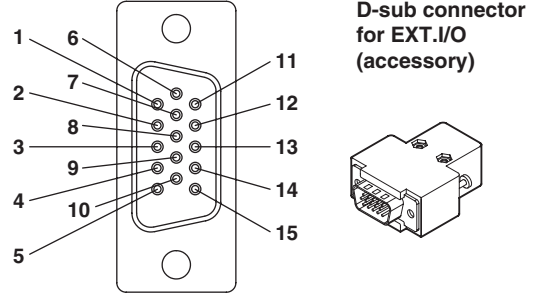

Specifications

Item	Specification
Connector type	D-sub type 9 pin (female)
Input/Output level	CMOS level
Trigger I/O	Connected to the WE bus for trigger signal (BUSTRG1/ BUSTRG2) (switch input and output) ^{*1}
Input impedance	Approx. 47 kΩ
Input pulse	100 ns or greater
Input maximum frequency	5 MHz
Maximum allowable input voltage	–3 V to +8 V (Overvoltage Category CAT I and II)
Output impedance	Approx. 100 Ω
Maximum output current	±3.2 mA
Time base I/O	Connected to the WE bus for Time base signal (CMNCLK) (switch input and output, rising edge active)
Input impedance	Approx. 47 kΩ
Input pulse	100 ns or greater
Input maximum frequency	5 MHz
Maximum allowable input voltage	–3 V to +8 V (Overvoltage Category CAT I and II)
Output impedance	Approx. 100 Ω
Maximum output current	±3.2 mA
Simple DIO input/output	Controls the output and detects the input condition ^{*2}
Number of bits	4 bits (internally pulled down)
Input impedance	Approx. 47 kΩ
Maximum allowable input voltage	–3 V to +8 V (Overvoltage Category CAT I and II)
Output impedance	Approx. 100 Ω
Maximum output current	±3.2 mA
Bus active output	Indicates bus active state (high level)
Output impedance	Approx. 100 Ω
Maximum output current	±3.2 mA

*1 Polarity of the BUSTRG1/BUSTRG2 signal at the EXT. I/O connector changes according to the trigger AND/OR setting (see section 4.6, “Setting the Trigger Source/Time Base Source/ Arming”) as shown below.
 AND: Trigger on Low level
 OR: Trigger on High level

*2 The simple DIO is a digital I/O for controlling the WE7000 from a dedicated software application. To control the output and detect the input condition, the WE Control API sold separately (707741) is required.

STATUS LED (A, B)

STATUS LED (A, B) indicates the operating status such as that of the dedicated software application. The on/off state can be controlled using the WE Control API (707741) sold separately.

2.5 Connecting Interface Cables

Connecting the Ethernet Cable

Connect the RJ-45 modular jack of an STP (shielded Twist-Pair) cable or UTP (Unshielded Twist-Pair) cable that is connected to a hub or similar device on the network to the 100BASE-TX port of the measuring station.

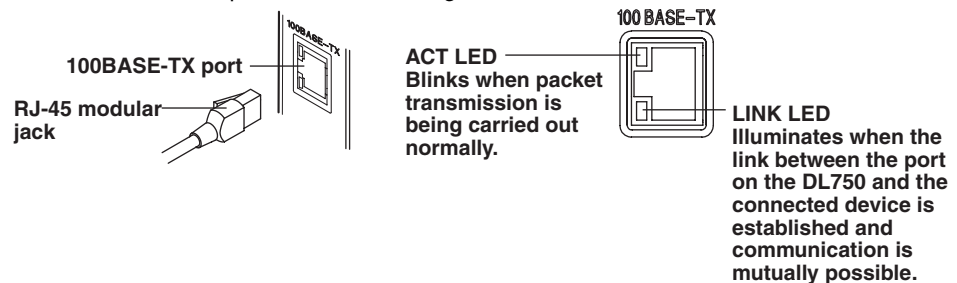

You need a hub to connect a PC and the measuring station.

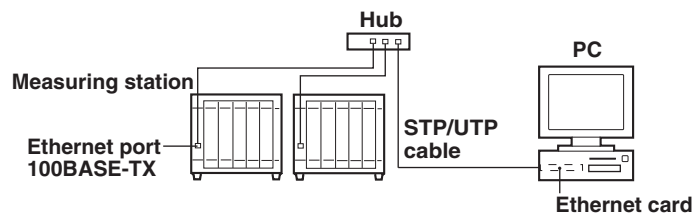

Note

- Use either of the following cables for making an Ethernet connection.
 - STP (Shielded Twist-Pair) cable (straight, category 5 or better)
 - UTP (Unshielded Twist-Pair) cable (straight, category 5 or better)
- To suppress effects from electromagnetic interference, use an STP cable.
- Refrain from directly connecting the PC to the Ethernet interface of the measuring station without going through a hub. Operations are not guaranteed for communications using direct connection.

Connecting the USB Cable

Connect a USB 2.0 cable to the USB port of the measuring station.

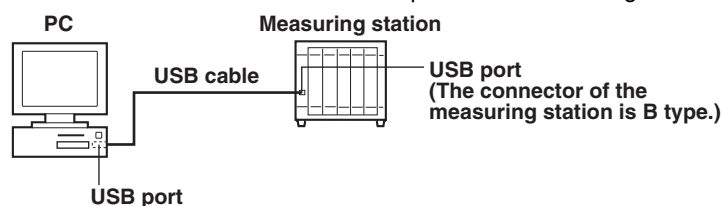

Note

- Be sure to use a USB cable conforming to USB 2.0. Otherwise, the WE7000 may not operate properly.
- Do not remove the USB cable while data measurement is in progress.

2.6 Connecting the Power Supply and Turning the Power ON/OFF

Connecting the Power Supply

Follow the warnings below to avoid electric shock and damage to the instrument.



WARNING

- Connect the power cord only after confirming that the voltage of the power supply matches the rated supply voltage of the measuring station.
- Connect the power cord after checking that the power switch of the measuring station is turned OFF.
- To prevent electric shock or fire, always use the power cord supplied by YOKOGAWA.
- Always use protective grounding to prevent electric shock. Connect the power cord of the instrument to a three-pole power outlet that has a protective ground terminal.
Do not use the function grounding under the power connecting section as the protective grounding terminal.
- Never use an extension cord that does not have protective grounding, otherwise the protection function will be invalidated.

Connecting Procedure

1. Check that the main power switch of the measuring station is turned off.
2. Connect the plug of the power cord to the power connector of the measuring station.
3. Plug the other end of the power cord into a power outlet that satisfies the conditions below. Always use protective grounding to prevent electric shock. Connect the power cord of the instrument to a three-pole power outlet that has a protective ground terminal.

Rated supply voltage: 100 to 120 VAC/200 to 240 VAC (automatic switching)

Rated supply voltage frequency: 50/60 Hz

Power consumption: 370 VA max (under maximum load) for 5 slot type,
570 VA max (under maximum load) for 9 slot type

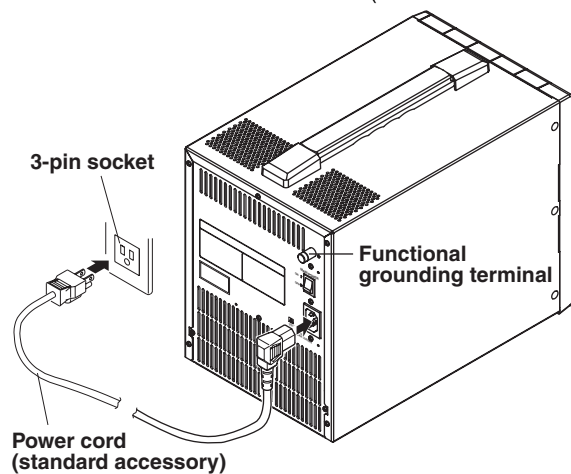

Switching the Power ON/OFF



CAUTION

- After turning OFF the main power switch on the rear panel, wait at least five seconds before turning ON the switch again. If you disconnect the AC plug while the main power switch is turned ON, you will also need to wait at least five seconds before reconnecting the AC plug again. Otherwise, the power supply section of the measuring station may become damaged.
- After turning OFF the standby power switch on the front panel, wait at least five seconds before turning ON the switch again. Otherwise, the measuring station or modules may not operate properly.
- There is a circuit breaker on the rear side of the measuring station WE800. If abnormal conditions are detected in the internal circuit, this circuit breaker will shutdown the power supply. In this case, you can recover the previous condition by pressing the reset button one minute after the shutdown. If the reset button does not return to the original position, WE800 has malfunctioned. Do not reset the measuring station repeatedly. Contact your nearest YOKOGAWA dealer.

There are two types of power switches; the main power switch and the standby power switch.

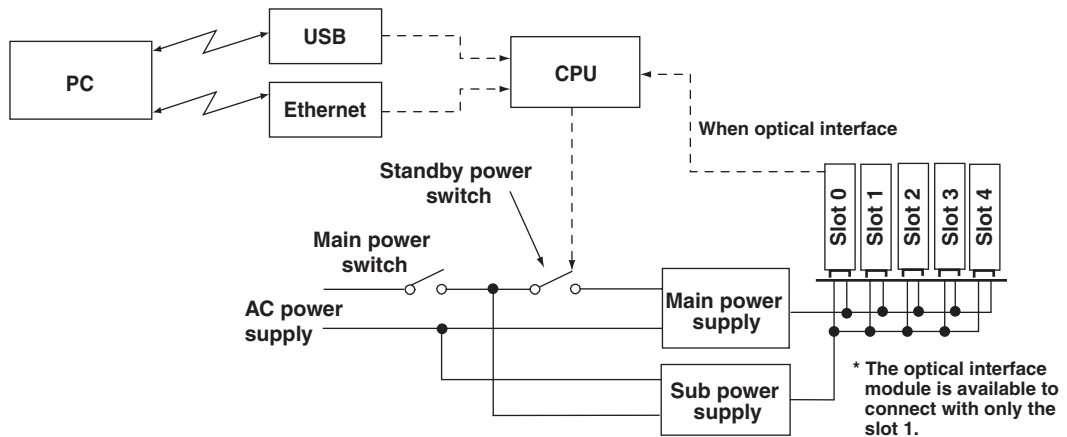

Main Power Switch

This switch is located on the rear panel of the measuring station. It brings the measuring station to the standby condition. This switch is left ON unless the instrument is not going to be used for a long period of time. Pressing the “I” side of the main power switch turns the power ON and “O” side turns it OFF. When turned ON, the power supply status LED above the standby power switch illuminates in orange. When using the optical interface module, the STANDBY LED at the top section of the module illuminates.

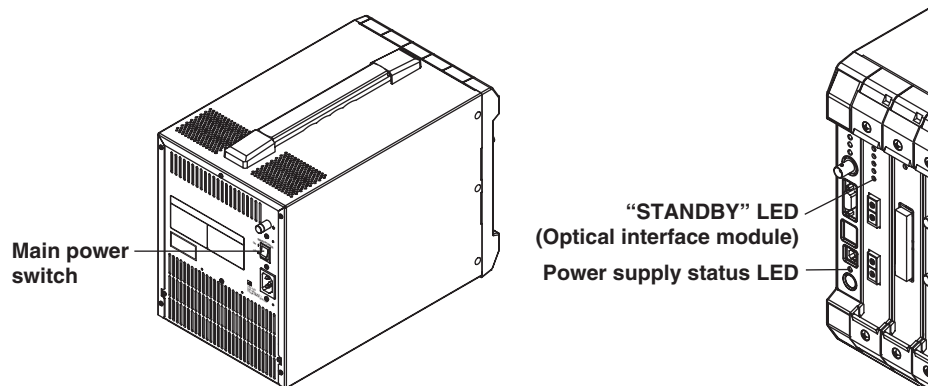

Standby Power Switch

This switch is located on the front panel of the measuring station. This switch brings the measuring station from the standby condition to the operating condition. Pressing the switch once turns the power ON and pressing it again turns the power OFF. When turned ON, the ON/OFF LED above the power switch illuminates in green. When turned OFF, the LED illuminates in orange. You can also turn ON/OFF the standby power switch from the PC. For details, see section 4.1, "Turning Measuring Station ON/OFF and Restarting" (page 4-1).

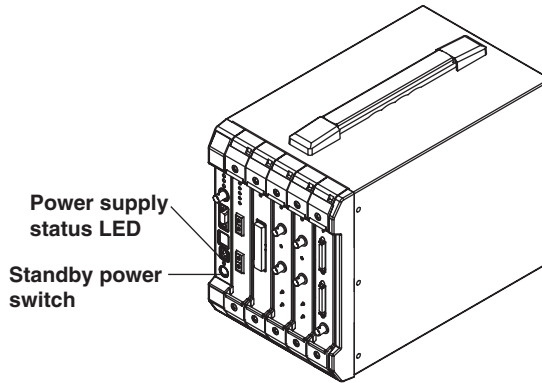

Power Supply Status LED

If the measuring station power is in the standby condition, the LED illuminates in orange. If the power is running, the LED illuminates in green.

Note

- Before turning the power on, check that the measuring station is correctly installed and the power cord is correctly connected.
- If you hear the buzzer sounding intermittently and the measuring station enters the standby condition automatically, the cooling fan is not rotating. This is probably a malfunction. Contact your nearest YOKOGAWA dealer.
- If you turn the power ON immediately after turning it OFF, it will take approximately 2 seconds for the power to actually turn ON due to the circuit protection of the measurement module.
- If the "STANDBY" LED of the optical interface module does not turn ON when the main power switch is turned ON, check the points listed below. For safety reasons, turn OFF the main power switch in order to check the power cord connection and the supply voltage. If the LED still does not turn ON after checking these points, it is probably a malfunction. Contact your nearest YOKOGAWA dealer.
 - Is the power cord connected properly?
 - Is the power supply voltage within the rated supply voltage indicated on page 2-9?
 - Is the optical interface module securely connected to the optical interface card?
 - Is the optical interface module properly installed into the measuring station?

3.1 PC System Requirements

Hardware

- **PC**
PC on which Windows 95/98/Me, Windows NT 4.0, Windows 2000 Pro or Windows XP Professional/Home Edition runs.
CPU: Pentium 400 MHz or higher.
ISA Bus: ISA bus expansion slot (full size) when using the WE7035/WE7036 optical interface card.
- **Internal memory**
128 MB or more
- **Hard disk**
100 MB of free disk space or more.
- **Drive**
One CD-ROM drive for installing the WE7000 Control Software.
- **Mouse or pointing device**
Mouse or pointing device supported by Windows 95/98/Me, Windows NT 4.0, Windows 2000 Pro or Windows XP Professional/Home Edition.
- **Display**
Display supported by Windows 95/98/Me, Windows NT 4.0, Windows 2000 Pro or Windows XP Professional/Home Edition. 1028 × 768 (XGA) or more, and High Color (65536 colors) or more.
- **Communication interface card**
To communicate by connecting to the Ethernet network (10BASE-T/100BASE-TX), you will need a NIC (network interface card) supported by Windows 95/98/Me, Windows NT 4.0, Windows 2000 Pro or Windows XP Professional/Home Edition and a driver to run the NIC.
To communicate using the optical fiber cable, WE7035/WE7036 optical interface card (Model: 707035 or 707036) made by YOKOGAWA must be installed.
- **USB**
Communication via the USB port is possible only on Windows 98 SE/Me, Windows 2000 Pro or Windows XP Professional/Home Edition. A USB I/F supporting USB 1.1 and USB 2.0 and a corresponding driver are required.
- **Printer**
Printer supported by Windows 95/98/Me, Windows NT 4.0, Windows 2000 Pro or Windows XP Professional/Home Edition. A printer driver for Windows 95/98/Me, Windows NT 4.0, Windows 2000 Pro or Windows XP Professional/Home Edition is necessary.

OS

Microsoft Windows 95/98/Me, Windows NT 4.0, Windows 2000 Pro or Windows XP Professional/Home Edition.

Note

- If you are using a version of Windows that includes Internet Explorer versions before 4.0, you must install Internet Explorer 4.0 or later.
- If Font Size in Windows Display Properties is set to Large Fonts, the characters displayed in the WE7000 Control Software will not be displayed properly. Make sure to set the Font Size to default (Small Fonts) when using the WE7000 Control Software.

3.2 Configuring the TCP/IP Settings of the PC

When using an Ethernet connection, you must set communication parameters, such as the IP address, using the PC. Communication parameters are specified for each Ethernet NIC that is installed in the PC. This section will describe the configurations of the Ethernet NIC used to connect to the measuring station.

For example, if you are connecting a PC and a measuring station to an independent Ethernet network, you can specify parameters as indicated in the next table.

Parameter	Value	Note
IP address	192.168.21. <u>128</u>	Set the same value as the IP address of the start parameter of the WE7000 Control Software as described in the next section. (The underlined section is an example. Set a value between 1 and 254.)
Subnet mask	255.255.255.0	Set the same value as the subnet mask that was specified for the measuring station.
Gateway	None	
DNS	Disable	
WINS	Disable	

Note

If the IP address and other parameters are to be obtained automatically using the DHCP server, the settings above are not necessary. In the [Local Area Connection Properties] > [Internet Protocol (TCP/IP)] > [Properties] > [Internet Protocol (TCP/IP) Properties], select [Obtain an IP address automatically].

The following procedure describes the steps for Windows 2000 Pro. Carry out similar steps for Windows 95/98/NT/XP.

1. From the [Start] menu, choose [Settings] > [Control Panel] to open the Control Panel folder.
2. Double-click [Network and Dial-up Connections].

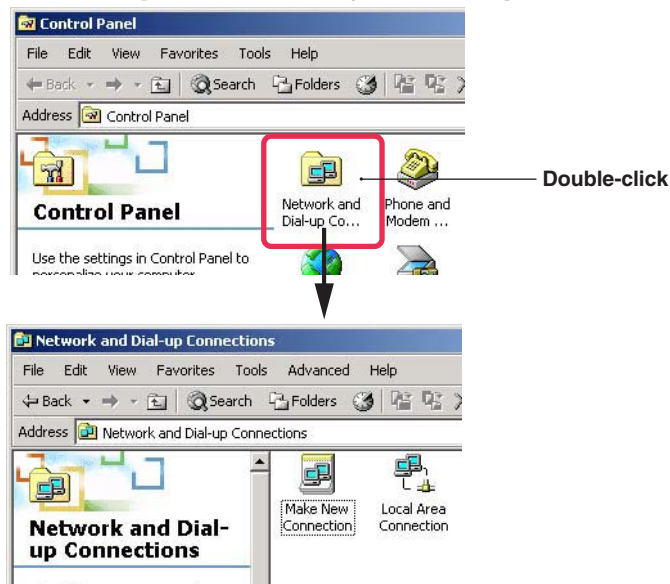

- Right-click the [Local Area Connection] icon and click [Properties] from the shortcut menu.

The Local Area Connection Properties dialog box opens as shown below.



- Select the [Internet Protocol (TCP/IP)] check box and click the [Properties] button.

The Internet Protocol (TCP/IP) Properties dialog box opens.

Select [Use the following IP address], enter the IP address and subnet mask, and click the [OK] button.

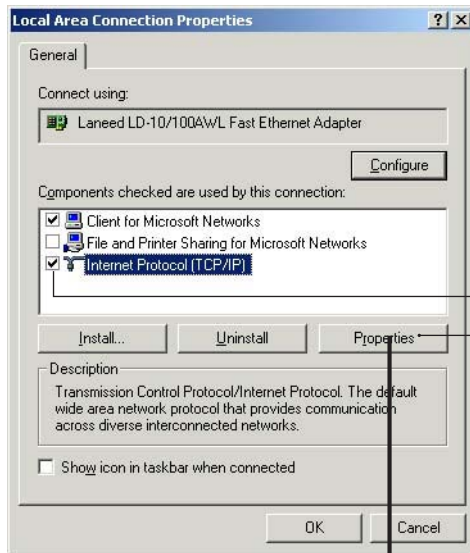

Select the check box
Click

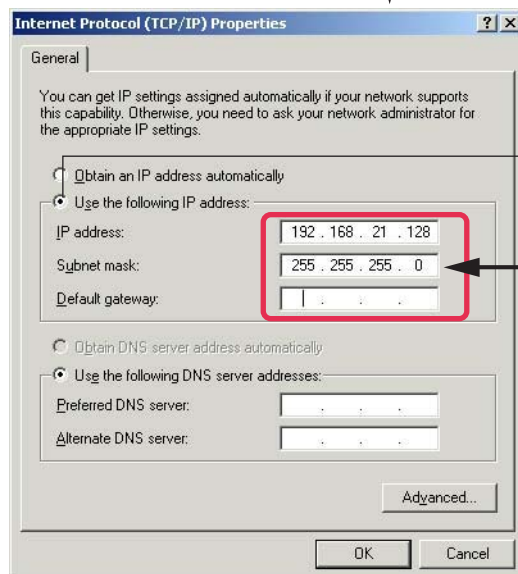

Select
Set the parameters by referring to the values indicated on the previous page

3.3 Installing the USB Driver

When performing communication between the measuring station and the PC via the USB, the USB driver must be installed. USB 1.1 and USB 2.0 are supported.

Note

If you are using Windows 98 SE or Windows Me, specify the weusb.inf file directly to install the USB driver.

You can specify the weusb.inf file from either of the two locations below.

(The default location is "C:\Program Files\WE7000\USBDriver.")

- The USBDriver folder on the CD-ROM.
- If the WE7000 Control Software (Ver. 5.0.1.0) is installed, the USBDriver folder in the installation folder.

Installing the USB Driver

1. When you first connect the WE500 or WE900 to the PC using a USB cable, the following window opens.



2. Click Next. The window below opens.
Select [Search for the best driver for your device (Recommended)] and click [Next].

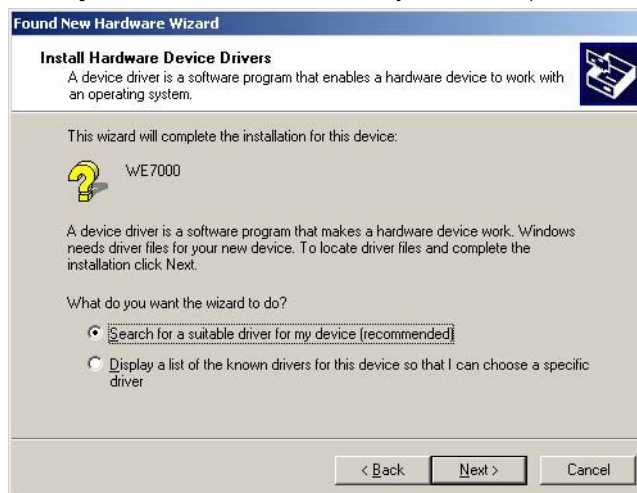

3. The following window opens.

Select the [CD-ROM Drive] check box and click [Next].

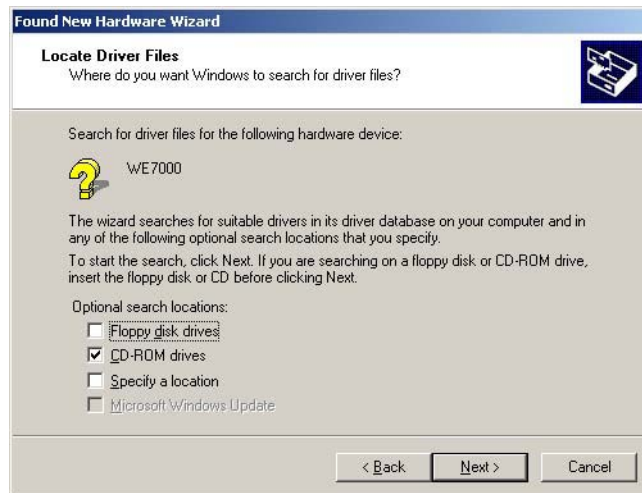

4. The following window opens.

Click [Next].



5. When the driver is installed correctly, the following window opens.

Click [Finish] to finish the installation.



Checking the Driver Installation

If the USB driver is installed correctly, the Device Manager window shows the driver as follows:

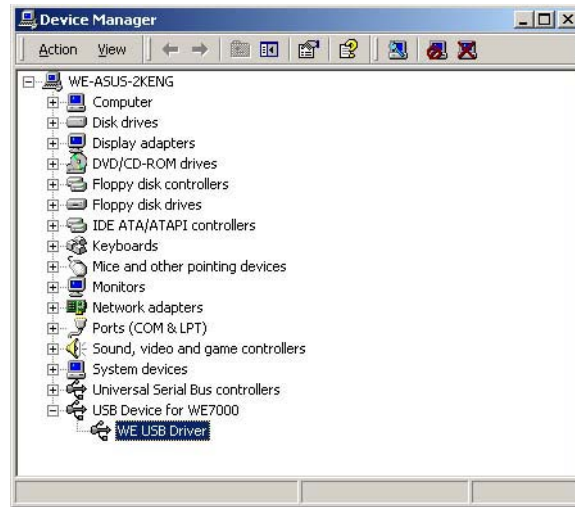

3.4 Installing the WE7000 Control Software

Before Installation

Take out the WE7000 Control Software Setup Disk (CD-ROM) that came with the measuring station. Exit all other programs that are currently running before starting the installation.

Start Installation

The following shows the installation procedure on Windows 95/98/Me. If you are using Windows NT 4.0, Windows 2000 Pro or Windows XP Professional/Home Edition, setup the program in a similar fashion.

Note

If you are making a connection using USB or optical communication, preparation (such as installing a driver) is needed before you can actually use it. For the setup procedure, see section 3.3, "Installing the USB Driver" for USB or the user's manual that comes with the optical interface card for optical communication. If you are making a connection via the Ethernet interface, you must configure communication parameters before you can actually use it. For the procedure, see section 3.2, "Configuring the TCP/IP of the PC."

1. Start Windows 95/98/Me.
2. Insert the WE7000 Control Software Setup Disk in the CD-ROM drive. A startup menu will automatically appear. Check that "WE7000 Control Software" is displayed in the list box of the startup menu, then click "Install Start."

If the auto run function of the CD-ROM is disabled, run the setup.exe file located at the root directory of the CD-ROM using My Computer or Explorer.

Note

To use the online help for the WE7000 Control Software, you will need version 3.0 or later versions of "Adobe Acrobat Reader." If you do not have "Adobe Acrobat Reader" installed on your PC, install the program after you finish installing the WE7000 Control Software. To install the Acrobat Reader, start the installer again and select "Adobe Acrobat Reader" from the list box of the startup menu that is shown below.



The installation program will start and the dialog box for setting the destination folder to install the software will be displayed.

3.4 Installing the WE7000 Control Software

3. After setting the destination folder, click "Next."

The default destination is set to "C:\Program Files\WE7000\." Change the destination as necessary.

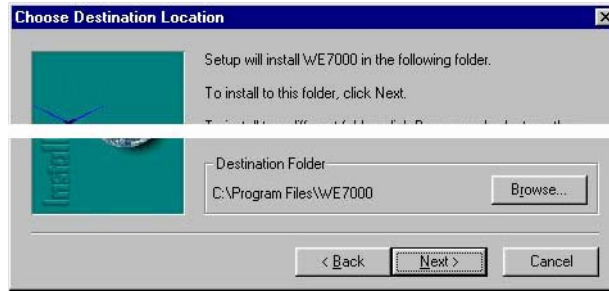

Program files will be copied to the hard disk and the progress will be displayed with a graph.

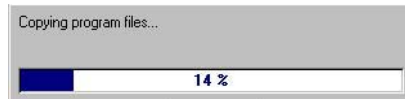

4. After the program files are copied, a [Create Shortcut Icons for Different Communication Methods] dialog box appears as shown below. Check the box corresponding to the communication method that you will be using. When starting the WE7000 Control Software, start options (parameters that are attached to the end of the shortcut target [WE7000.exe"]) that correspond to the communication method must be specified. By checking the appropriate box, the start options are automatically added. The default start options are shown below.

Optical: "-comm optical devicename=WE7036"

- On Windows 95

Ethernet: "-comm ethernet95 IP=192.168.21.128
NETMASK=255.255.255.0 PORTNO=34191 GROUPNO=0"

- On Windows versions other than Windows 95

Ethernet: "-comm ethernet PORTNO=34191 GROUPNO=0"

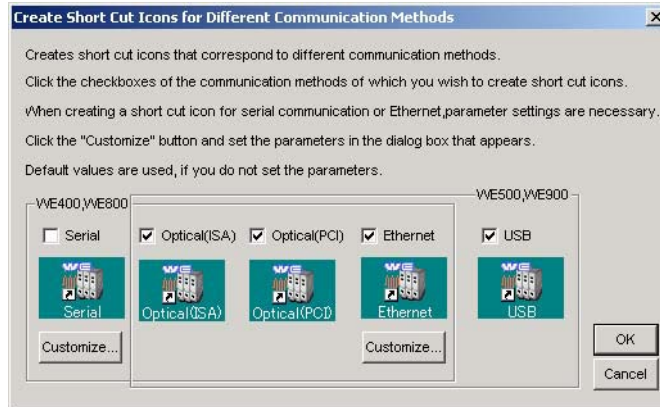

To set the IP address, subnet mask, port number, and group number for Ethernet communications, click [Customize] under [Ethernet] and change the settings in the dialog box shown below.

- On Windows 95

For [IP Address] and [Subnet Mask], enter the values that are specified for the PC. Enter the port number and group number as necessary.

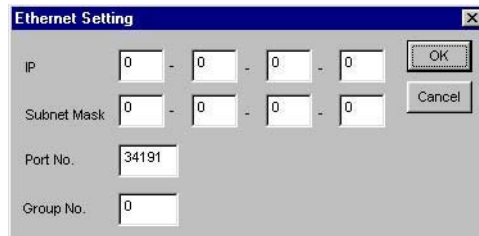

- On Windows versions other than Windows 95

On Windows versions other than Windows 95, [IP Address] and [Subnet Mask] are automatically detected. Thus, you do not need to set them. Enter the port number and group number as necessary.

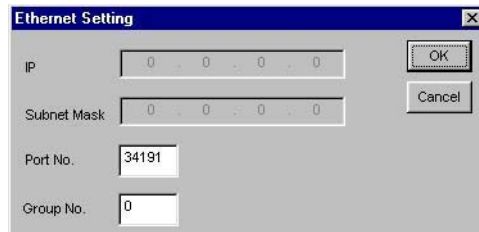

5. Click [OK] in the [Create Shortcut Icons for Different Communication Methods] dialog box.
6. When the setup completes successfully, the following dialog box appears. Click [Finish].

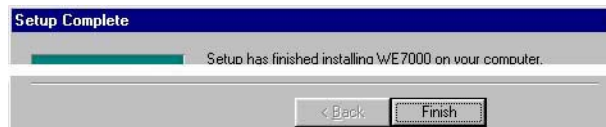

[WE7000] shortcut icons are created on the desktop according to the operation in step 5 as shown below. A menu item is also registered in the start menu.



Start Options

Selecting [Properties] in the menu that appears by right-clicking the [WE7000] shortcut icon opens the following dialog box. The start options that were specified in step 5 are written to the [Target] box in the [Shortcut] tab. To change the start options after setting up the WE7000 Control Software, change the settings in this [Target] box.

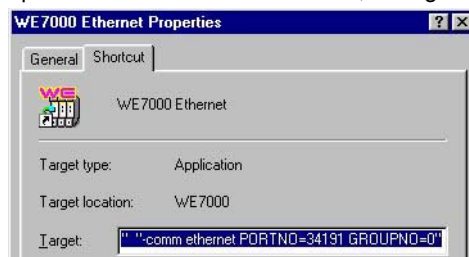

3.5 System Configuration when Using Ethernet Communications

System Configuration

The following is an example in the case of connecting the measuring station and a PC to an Ethernet network at a time.

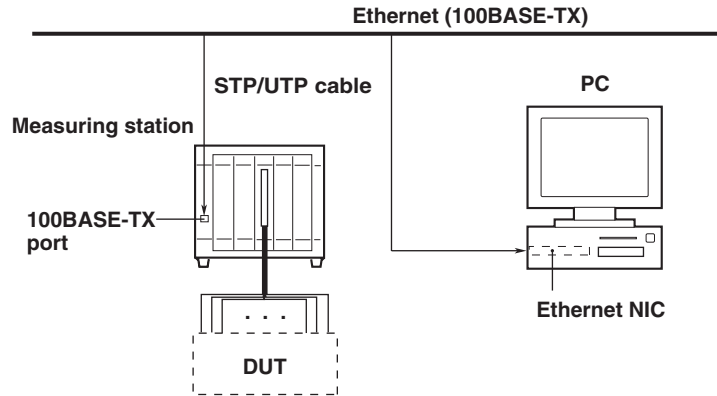

Network Configuration

Up to three measuring stations can be connected to each PC existing in the same subnet. Each PC and the measuring stations with which it will be communicating, are configured as one group. If there are multiple PCs that need to communicate with different triplet groups of measuring stations over the same Ethernet segment, multiple groups can be set. In this case, communication is possible only within the same group.

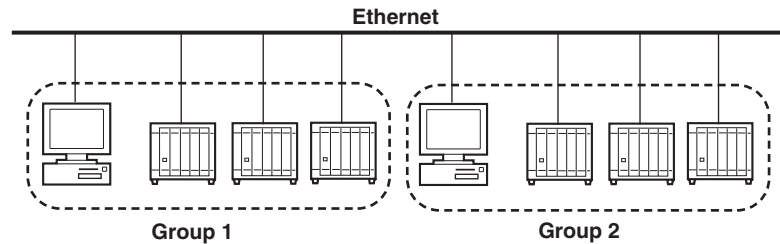

To reduce the amount of network traffic on a public use Ethernet network, the PC and the measuring stations can be connected via their own independent network. In this case, the PC and the measuring stations should be in the same IP subnet. For example, as shown in the following figure, each PC has two Ethernet NICs, one for connecting with other PCs and one dedicated for use with the WE7000 measuring stations. The two cards are configured with different IP addresses.

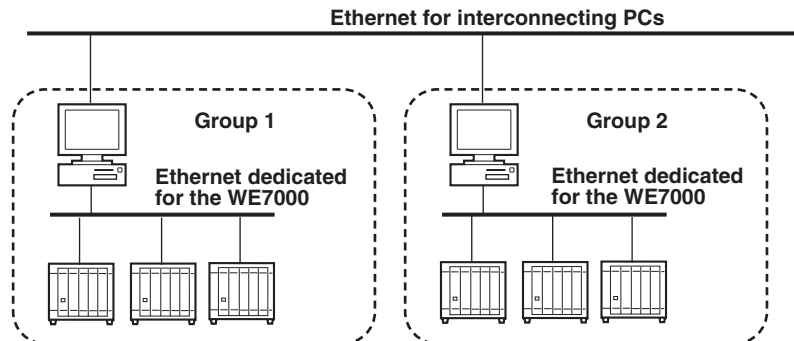

Note

If there are multiple Ethernet NICs installed on a PC, you will specify which Ethernet NIC will be used to communicate to the WE7000 by specifying the IP address through the start option of the WE7000 Control Software (see section 3.6, "Configuring Ethernet Communications of the WE7000 Control Software.")

Setting Procedure

See the ethernet communication according to the following flow diagram.

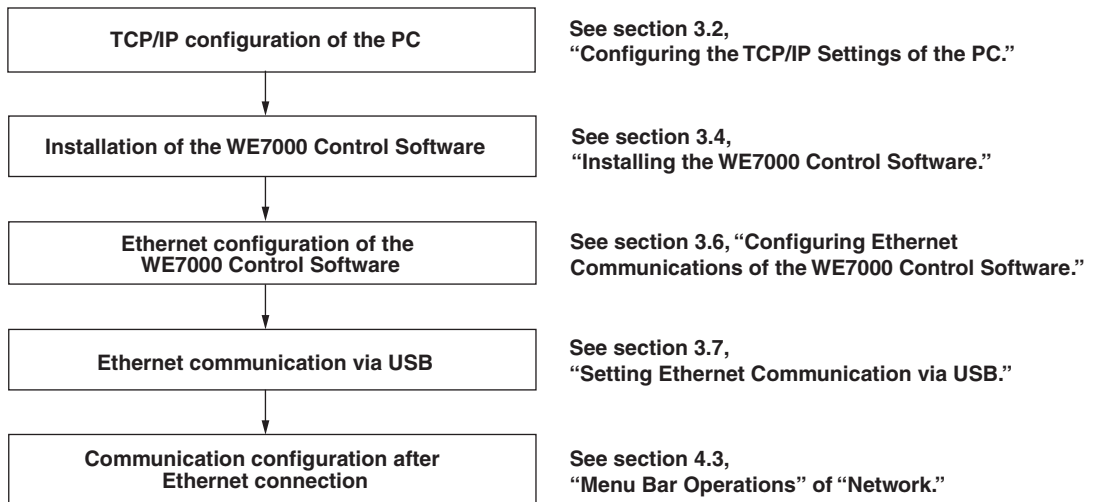

3.6 Configuring Ethernet Communications of the WE7000 Control Software

1. Select the [WE7000] shortcut icon and click the right mouse button.
2. Select [Properties], and click the [Shortcut] tab in the properties window that appears.
3. [... WE7000.exe" "-comm ethernet" ([ethernet95] in place of [ethernet] on Windows 95) is already entered in the [Target] textbox. Enter the following start parameters behind it.

Separate each parameter with a space or a tab and close the parenthesis at the end. The parameters are not case-sensitive. Set all parameters except the IP address to be the same as the parameters written to the Fast Ethernet Module.

The “IP address” and “Subnet mask” can normally be skipped. However, they must be specified in the following cases (for details, see the Note below):

- **When using Windows 95.**
- **When using multiple Ethernet NICs.**

The group number is specified when multiple PCs and measuring stations are connected to the same network and you wish to avoid having multiple PCs controlling a particular measuring station. For information about groups, see “Network Configuration” on previous page. For changing the group of the measuring station, see “See Group” on page 4-8.
- IP address: IP = address of the PC (example: 192.168.21.128)
- Subnet mask: NETMASK = subnet mask (example: 255.255.255.0)
- Port number (can be omitted): PORTNO = port number (example: 34191 “ default setting)
- Group number (can be omitted): GROUPNO = group number (example: 0 “ default setting)
- Communication mode (can be omitted): COMPATIBLE = ON or OFF (example: ON “ default setting)

Entry example: "-comm ethernet IP=192.168.21.128 NETMASK=255.255.255.0 PORTNO=34191 GROUPNO=1 COMPATIBLE=OFF"

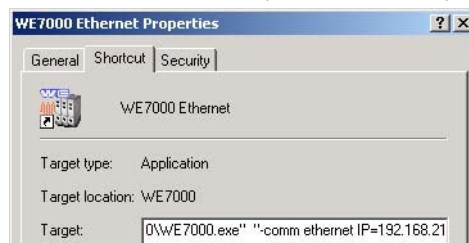

Note

- On Windows 95, the IP address and subnet mask must be specified. This is because the IP address and subnet mask that are assigned to the PC cannot be searched under the Windows 95 environment. When the IP address is automatically obtained through the DHCP server, the IP address is variable. Therefore, communications with the Fast Ethernet Module may not be possible, because the specified IP address and the IP address that is dynamically obtained may not match. To avoid this kind of problem, we recommend that you assign a fixed IP address to the PC instead of using the DHCP server in a Windows 95 environment.
- On Windows operating systems other than Windows 95 (Windows 98/NT 4.0/2000 Pro), the IP address and the subnet mask do not need to be specified if only one Ethernet NIC is installed. When multiple Ethernet NICs are installed, specify which card will be used by specifying the IP address of that card. You do not have to specify the subnet mask.
- If there is at least one Ethernet Module WE7051 in the same network, omit the communication mode parameter or specify “COMPATIBLE=ON.” If there are no WE7051 in the network and the COMPATIBLE dip switch is set to the “0” setting, make sure to specify “COMPATIBLE=OFF.”

4. Click the [OK] button.

3.7 Setting Ethernet Communication via USB

The procedure below is the configuring communication parameters when DHCP is not used.

Connect the PC and the measuring station using the USB cable according to "Connecting the USB Cable" on page 2-8. If you are using the USB for the first time, install the USB driver (see section 3.3, "Installing the USB Driver"). Then, carry out the procedure below. If the [WE7000] shortcut icon for USB communication was already created when you set up the WE7000 Control Software and you are using the USB for the first time, install the USB driver and then carry out the procedure from step 5.

1. Select the [WE7000] shortcut icon and click the right mouse button.
2. Select [Properties], and click the [Shortcut] tab in the properties window that appears.
3. In the [Target] textbox, enter a space after [WE7000.exe] followed by ["-comm USB"].

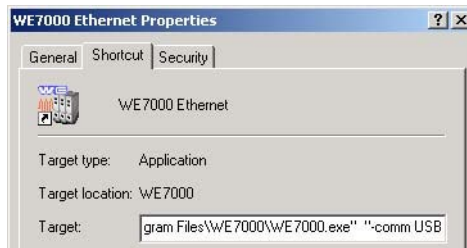

4. Click the [OK] button.
5. Turn ON both the main power switch and the standby power switch of the measuring station and double-click the [WE7000] shortcut icon.
6. Using the menu bar that appears, select [Set IP] from the [Network] menu to open the communication settings dialog box.



7. Check that the appropriate station name is displayed in the [Station Name] list box.

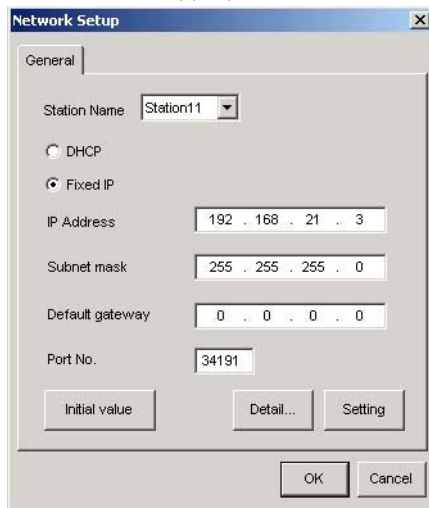

8. Select the [Fixed IP].
9. Set each parameter and click the [Setting] button.
The default value of each parameter is as follows:
 - **IP address**
Specify the IP address to assign to the measuring station. The default IP address is “192.168.21.3.”
 - **Subnet mask**
Specify the mask that is used to determine the network address from the IP address. The default setting is “255.255.255.0.”
 - **Default gateway**
Specify the IP address of the default gateway that is used when communicating with other devices on a different network. Specify “0.0.0.0” when there is no gateway. The default setting is “0.0.0.0.”
 - **Port number**
Specify the port number of the process that receives UDP (User Datagram Protocol) packets of file transfers. The default setting is “34191.” This parameter is also needed when using DHCP, but no configuration is necessary if you are using the default settings.

Note

The IP address is used to distinguish between the various devices connected to the Internet which communicate using the TCP/IP protocol. The address is a 32-bit value normally expressed in four octets (each 0 to 255), each separated by a period as in 192.168.1.1. The IP addresses that are used over the Internet are managed by InterNIC. However, if the PC and measuring stations are connected over their own independent network as indicated in the bottom figure in section 1.1 “Network Configuration,” then IP addresses can be assigned arbitrarily within that network. The following three numerical ranges of IP addresses are provided for such use.

192.168.0.0 through 192.168.255.255, 172.16.0.0 through 172.31.255.255, and 10.0.0.0 through 10.255.255.255

As factory default, the WE7000 is set to use “192.168.21.0 to 192.168.21.255” which is contained in the first of the IP address ranges just described. If there are no existing devices that use IP addresses in the range “192.168.21.0 to 192.168.21.255,” and the PC and measuring stations are connected over their own independent network, then the factory default settings can be used.

If you change the settings, click [Setting]. If a confirmation dialog box opens, click [Yes]. This will restart the measuring station. The new settings are applied when the WE7000 restarts.

Next, to connect to Ethernet, carry out the steps below and follow the procedure given in “Network” (page 4-8).

1. Select [Exit] from the [File] menu to quit the WE7000 Control Software.
2. Remove the USB cable and connect an STP or UTP cable to the 100BASE-TX port for Ethernet communication.

3.8 Starting and Exiting the WE7000 Control Software

Starting

Double-click the [WE7000] shortcut icon that corresponds to the communication method that is being used. You can also select from the [Start] - [Programs] menu.



The menu bar and station list window of the WE7000 Control Software are displayed as shown.

- When the measuring station is not connected or the main power switch is turned OFF

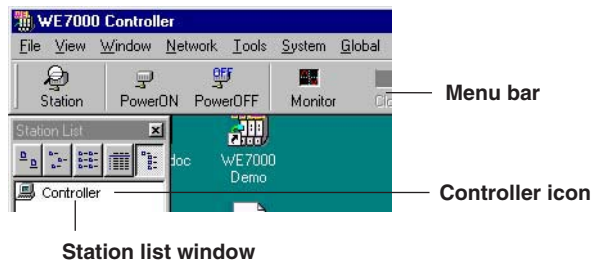

- When the measuring station is connected, the main power switch is turned ON, and the standby power switch is turned OFF

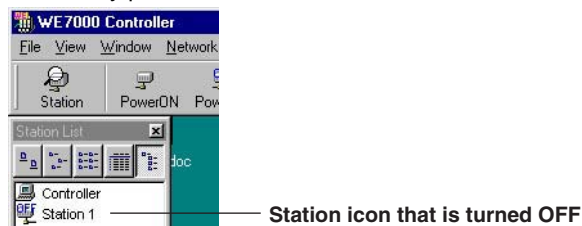

- When the measuring station is connected, the standby power switch is turned ON

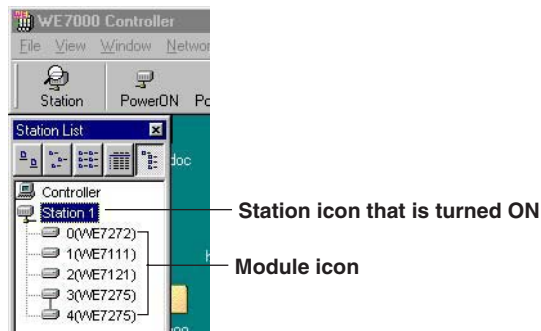

Note

- If the "Cannot open communication driver." error message is displayed at startup, the following are possible causes. For the installation procedures of the optical interface card and optical interface driver, see the user's manual that came with the optical interface card.
 - The optical interface card is not installed properly.
 - The optical interface driver is not installed properly.
- If the station icon does not appear when the main power switch of the measuring station is turned ON and the measuring station is connected to the Ethernet network, check to see that the communication settings of the Fast Ethernet module and the start options of the [WE7000] shortcut icon are correct.

Exiting

Click the “×” button on the upper right corner of the window, or select “Exit” from the “File” menu.

Note

- For the procedure on saving the setup data, see section 4.3, “Menu Bar Operations.”
- If you save the setup data, you will be able to start the WE7000 Control Software according to the setup data by double-clicking the file (file with a “.wes” extension, see figure above).
- The behavior of the program when you exit the program is determined by the item that is selected under [Action when saving the setup data file] in [Configuration Settings] of the [System] menu.
- When [Display a confirmation dialog box] is selected
If you start the program without specifying the setup data file (a file with .wes extension), the following dialog box appears for you to confirm the saving of the setup data.
To save the settings immediately before you exit the program as default setup data, click [Yes]. Otherwise, select [No]. The same holds true when the [Load default setup data at startup] check box is not selected.

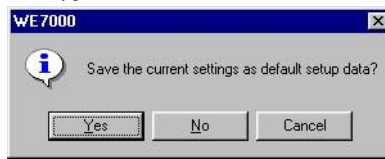

If you specified a setup data file when you started the program, the following confirmation dialog box opens. To change the setup data, click [Yes]. To not save the setup data and close the program, click [No].



- When [Automatically overwrite the file] is selected
If you started the program without specifying the setup data file, the settings that exist immediately before the program is closed are automatically saved as default setup data. The same holds true when the [Load default setup data at startup] check box is not selected. If you started the program by specifying a setup data file, that file is automatically overwritten.
 - When [Do not save] is selected
Regardless of whether a setup data file was specified when you started the program, the program closes without saving the modified setup data.
 - The default setup data is used when the [Load default setup data at startup] check box is selected and the program is started using the previous setup data (when you closed the program the previous time).
-

3.9 Displaying Help

The online help for the WE7000 Control Software is in PDF format. You will need “Adobe Acrobat Reader” (version 3.0 or later) to display the online help. If it is not installed on your PC, install it according to the procedure given on page 3-2.

Help on Menu Bar

Selecting [WE7000 Help] from the [Help] menu, or clicking the button shown in the following figure will start Acrobat Reader. Help regarding the operation of the menu bar is displayed.

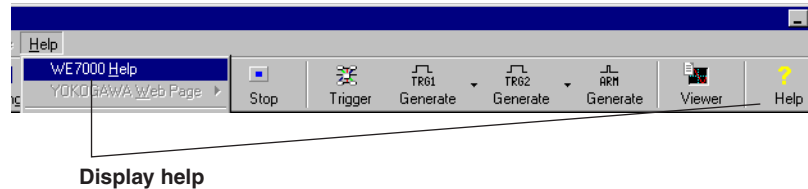

Help on Station Window

Right-clicking a station icon that is turned ON in the station list window displays the following station menu. Selecting [Station Help] in this menu will start Acrobat Reader. Help regarding the operation of the station window (the window that appears when [Open] in the station menu is clicked) is displayed.

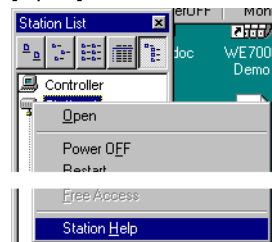

Help on Measurement Module

Right-clicking the module icon in the station list window displays the active module menu shown in the lower left figure. The active module menu is also displayed by clicking [Active Module] in the station window menu as shown in the lower right figure. Selecting “Module Help” from this menu will start Acrobat Reader. Help regarding the selected module is displayed.

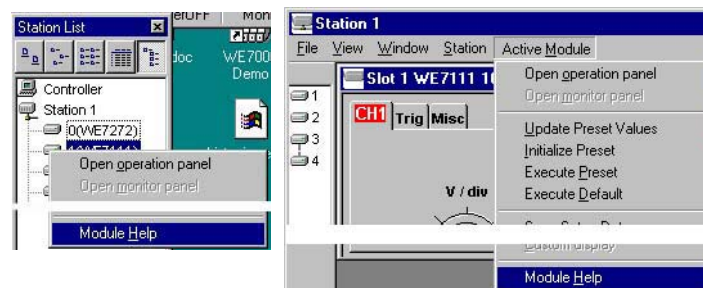

Help on Waveform Monitor/Viewer

Clicking the button shown in the following figure in the waveform monitor or viewer will start Acrobat Reader. Help regarding the operation of the waveform monitor or viewer is displayed.

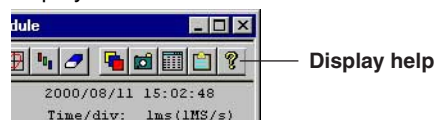

4.1 Turning the Measuring Station ON/OFF and Re-starting

Turning Measuring Station ON/OFF

If the main power switch (see page 2-10) is turned ON and the measuring station is in the standby condition, the standby power switch can be turned ON/OFF using the WE7000 Control Software.

The condition of the standby power switch (ON/OFF) of the measuring station is displayed in the station list window of the WE7000 Control Software. A measuring station that has its standby power switch turned off will have "OFF" displayed on top of the station icon in the station list window.

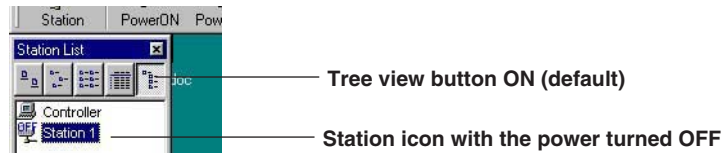

Note

If the main power is turned on, communication is operational ("STANDBY" LED is ON) regardless of the standby power switch condition.

The following two methods are available in turning ON/OFF the standby power switch on the measuring station.

- Turn ON/OFF the standby power switch on a particular measuring station**
 Right-clicking the measuring station being turned ON/OFF displays a station menu as shown below. If the standby power switch of the measuring station is currently ON, then you can select "Power OFF." If it is currently OFF, then you can select "Power ON."

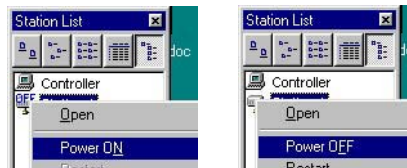

- Turn ON/OFF the standby power switch on multiple measuring stations**
 Click [Power ON] or [Power OFF] on the menu bar or select [Power ON] or [Power OFF] from the [Global] menu to turn ON/OFF the standby power of multiple measuring stations at once. The applicable measuring stations that are turned ON/OFF are selected in the dialog box that appears by right-clicking the button. By default, all measuring stations are selected. Remove the check from the check box to deselect measuring stations.

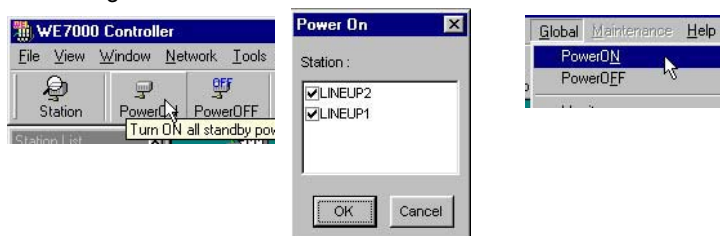

Note

If the station list window is not showing the tree view, you can select multiple station icons and turn ON/OFF the standby power switch of those measuring stations by selecting [Power ON] or [Power OFF] in the station menu that appears by right-clicking the selected station icons. In this case, the conditions of the selected measuring stations do not affect the operation. All selected measuring stations are turned ON/OFF.

4.1 Turning the Measuring Station ON/OFF and Restarting

Note

If a station icon in the station list window is displayed with character string [FAN STOP] as shown in the following figure, the cooling fan has malfunctioned. Contact your nearest YOKOGAWA dealer to have it repaired. The measuring station's standby power switch is automatically turned OFF 60 seconds after detecting a malfunction.



Restarting the Measuring Station

If you wish to restart the measuring station from the initial condition or if the operation of the measuring station becomes abnormal, you can reset the measuring station and each of the modules by following the operation below. All parameter settings will be set to their preset values (see page 4-13). However, if you open the WE7000 Control Software using the setup data file or change the settings using the setup data file, settings will take on the values as specified by the setup data file not the preset values.

Select [Restart] from the menu that appears by right-clicking the station icon in the station list window. As in the case with turning ON/OFF the power, you can reset multiple measuring stations at once by having multiple stations selected beforehand.

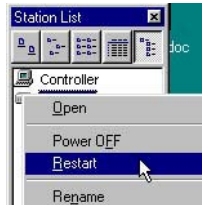

4.2 Changing the Name of Controller/Measuring Station and Entering Comments

Changing the Name

You can assign names to the controller (connected PC) and each of the measuring stations. If you click the controller icon or the station icon that is turned ON so that it is selected in the station list window, you can change the name of the icon. You can assign any name within the rules of Windows that you are using.

However, if the station window of the measuring station you wish to change the name of is being displayed, you cannot change the name in this manner (see page 4-21).



Changing the Station Name on Properties Display

You can also change the name by selecting [Rename] or [Properties] in the menu that appears by right-clicking the station icon in the station list window. In the properties display dialog box, you can also enter a comment to be associated with the measuring station.

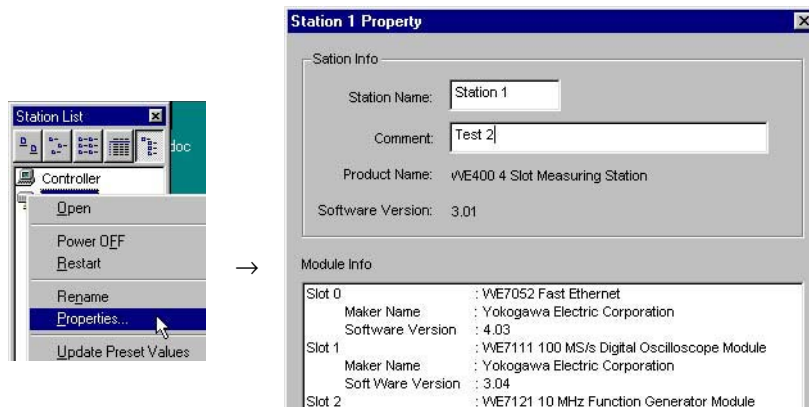

Verifying Name and Comment at the Details Display

Pressing the details display button will display a list of comments. Information corresponding to the condition such as “Power OFF” (Standby power switch OFF) or “Fan Stop” (Cooling fan has stopped abnormally) is displayed in the [Status] column.

Detail View

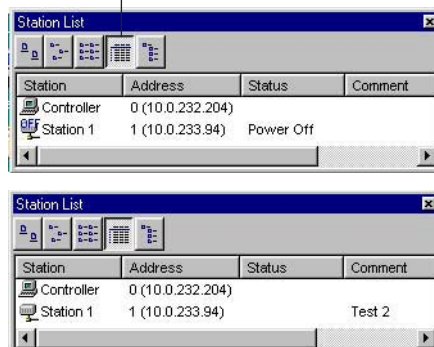

4.3 Menu Bar Operations

Tool Button

The menu commands that are frequently used are assigned to tool buttons. For the details of the operation of each button, see the description of the corresponding menu command. The tool buttons shown below appear by default. You can change the number and the position of the tool buttons that are displayed in the dialog box that appears by selecting [Tool Bar] - [Customize] on the [View] menu.

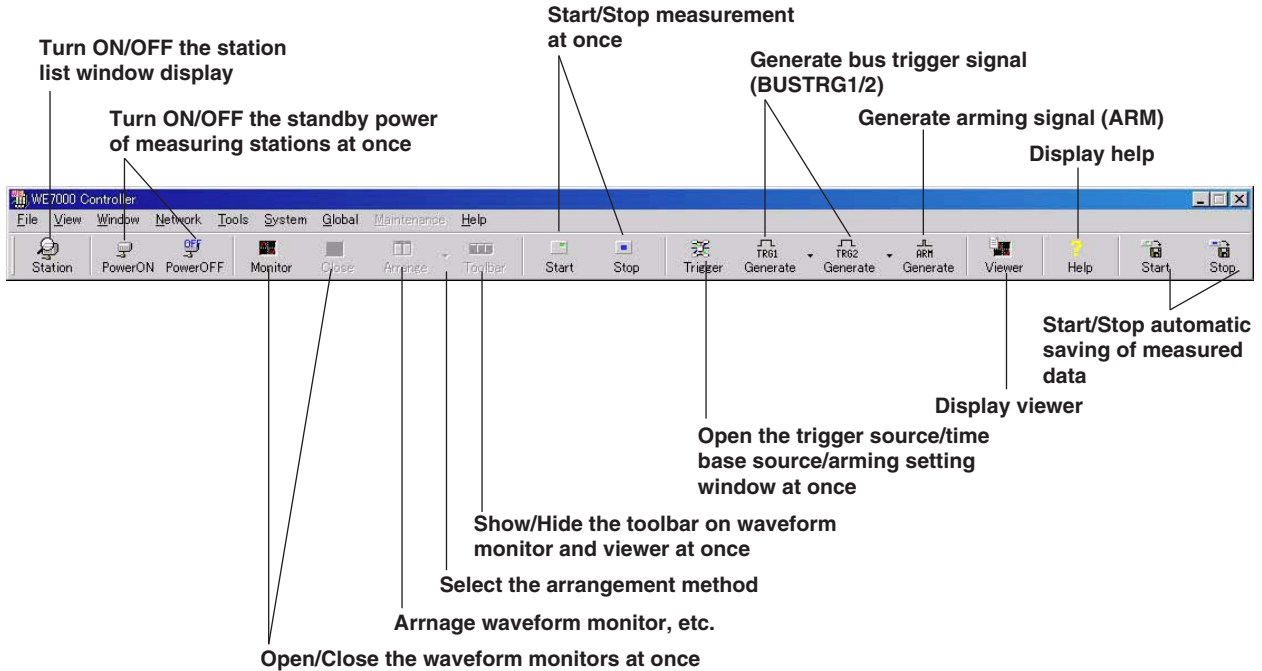

File Menu

Open

Select this menu command when selecting a setup data file (".wes" extension) that was stored previously and changing its settings or when selecting a waveform data file (".wvf" extension) and starting the viewer. The following dialog box is displayed for selecting the file.

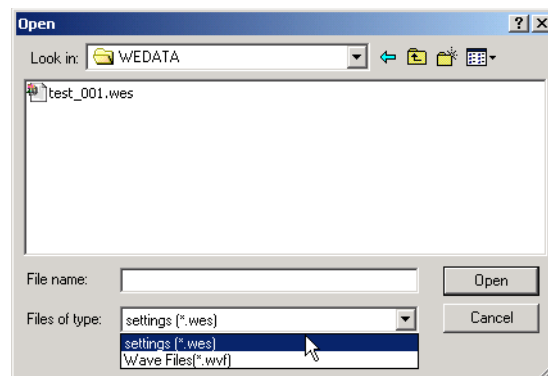

Selecting a setup data file and clicking [Open] displays a dialog box that asks you whether you will save the current setup data. To save the current setup data, click [Yes], enter the file name in the dialog box that appears, and save the data. When the save operation is complete or if you click [No], the settings are changed.

Note

If the standby power switch of the measuring station is not turned ON when saving the current setup data, information regarding the operations inside the measuring station is not stored. In addition, the settings of the waveform monitor are not saved, if the waveform monitor is not displayed when the setup data are stored.

Save Current Condition

Overwrites the current setup data to the same setup data file. This command can be executed only when the WE7000 Control Software is started using the setup data file or the setup data file is opened after starting the software and changing the settings.

Save Current Condition to Another File

The setup data can be saved to a file. By double-clicking the setup data file that is stored, the WE7000 Control Software starts according to the setup data. In addition, you can open the setup data file after starting the WE7000 Control Software to change the settings. Selecting [Save Current Condition to Another File] displays the following dialog box. Specify the destination and the file name.

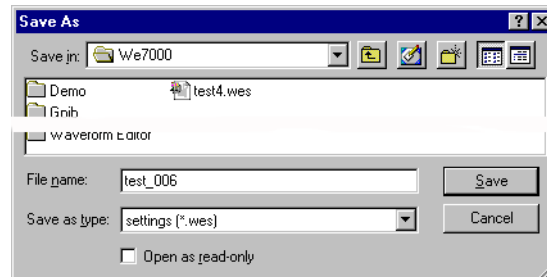

Note

- A file extension “.wes” is added to the file name. A file with the name “setup data file name+station name.bin” is also created in the same location. This file is required when opening the setup data file. Please do not erase it. By creating a shortcut of the setup data file on the desktop, you can start the WE7000 Control Software according to the setup data by double-clicking the shortcut icon.
- If the [Automatically overwrite the file] check box under [Action when saving the setup data file] in [System Settings] of the [System] menu is selected, the setup information is automatically written to the setup data file when you exit the program. However, if a setup data file is not specified when the program is started, the settings that exist immediately before the program is closed are saved as default setup data. The same holds true when the [Load default setup data at startup] check box is not selected. If a setup data file was specified when the program was started, that file is overwritten.
- When you save the setup data, the file name is registered in the menu as shown below. You can also change the setup data by selecting one of the file names here. Up to four files are registered.

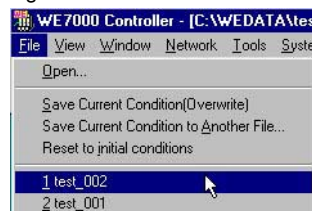

Reset to initial conditions

You can clear the current setup data. Select this command to reset the setup data to factory default, such as when the [Load default setup data at startup] check box is selected in [Configuration Settings] of the [System] menu.

Note

The module's setup data is not reset to default conditions, if measurement is started on the module. Stop the measurement before carrying out the operation.

Exit

Select this command menu to exit the WE7000 Control Software.

Note

- The behavior of the program when you exit the program is determined by the item that is selected under [Action when saving the setup data file] in [Configuration Settings] of the [System] menu.
- When [Display a confirmation dialog box] is selected
If you start the program without specifying the setup data file (a file with .wes extension), the following dialog box appears for you to confirm the saving of the setup data.
To save the settings immediately before you exit the program as default setup data, click [Yes]. Otherwise, select [No]. The same holds true when the [Load default setup data at startup] check box is not selected.

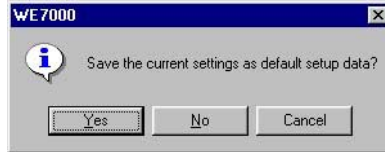

If you specified a setup data file when you started the program, the following confirmation dialog box opens. To change the setup data, click [Yes]. To not save the setup data and close the program, click [No].



- When [Automatically overwrite the file] is selected
If you started the program without specifying the setup data file, the settings that exist immediately before the program is closed are automatically saved as default setup data. The same holds true when the [Load default setup data at startup] check box is not selected. If you started the program by specifying a setup data file, that file is automatically overwritten.
- When [Do not save] is selected
Regardless of whether a setup data file was specified when you started the program, the program closes without saving the modified setup data.
- The default setup data is used when the [Load default setup data at startup] check box is selected and the program is started using the previous setup data (when you closed the program the previous time).

View

Tool Bar

- Text Labels
Turns ON/OFF the characters that are displayed under the tool buttons of the main menu. If characters are displayed when the resolution of the PC display is 800 x 600 or lower, a section of the menu bar will not be displayed. If you turn OFF the character display through this operation, the entire menu bar will be displayed.
- Customize
The following dialog box is displayed. You can delete, add, or move the tool buttons or tool separators. Click [Reset] to set the toolbar back to default.

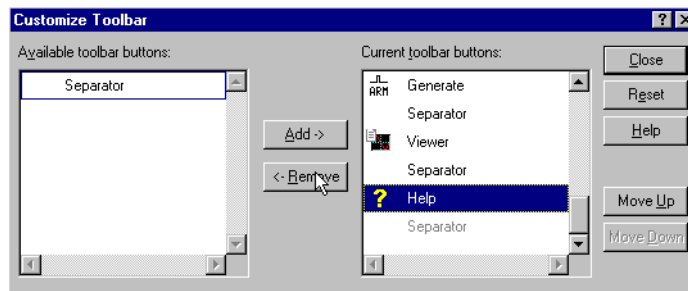

- **Monitor/Viewer**
Turns ON/OFF the toolbar of the waveform monitor and the viewer used display the stored data as a waveform. You can also carry out the same operation by clicking [Toolbar] shown below.



Station List Window

Select this menu command to show or hide the station list window. You can also carry out the same operation by clicking [Station] shown below.



For the operations on the station list window, see section 4.4, “Station List Window Operations.”

Measured Data Save Operation Monitor

This menu command is used to set whether or not to open the monitor window that indicates the save condition of the measured data when starting the save operation. If a check mark is displayed before the characters [Measured Data Save Operation Monitor], the monitor window opens. For the displayed information and operation of the monitor window, see “Monitoring the Save Operation of Measured Data” in section 4.8, “Saving Waveform Data/Converting Files.”

Refresh

When connected to the Ethernet network, the WE7000 Control Software does not automatically detect changes in the configuration of the measuring stations such as the addition or deletion of measuring stations from the Ethernet network, and the OFF state of the main power switch of measuring stations. Only by selecting [Refresh], are the most current configurations of the measuring stations identified and updated in the display.

Window

Cascade Panel Windows

When multiple operation panels of measuring stations are displayed, the operation panels are displayed in a cascaded fashion.

Close All Panel Windows

Closes all operation panels of measuring stations that are displayed.

Tools

Convert File

Displays a dialog box used to convert the stored waveform data to ASCII data in CSV format or a floating-point format data. For the procedure, see “Converting Files” in section 4.8, “Saving Waveform Data/Converting Files.”

Convert CSV to WE7121

Displays a dialog box used to convert ASCII waveform data in CSV format to arbitrary waveform data for WE7121. For the procedure, see the User’s Manual (IM707121-01E) for the 10 MHz Function Generator Module WE7121.

Run Viewer

Opens the Viewer that is used to display the waveform of the measured data that are stored to files. Multiple Viewers can be opened.

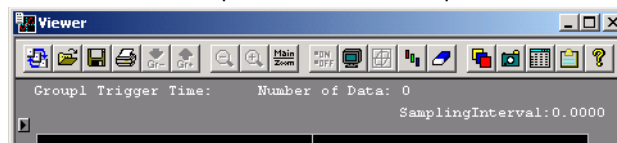

You can also carry out the same operation by clicking [Viewer] shown below.



For the operations of the Viewer, see the help provided with the Viewer.

Assorted Module Binding Function

Enables displaying of waveforms of different types of modules on the same Waveform Monitor and saving of the waveforms to the same file. For details on the operation, see section 4.9, "Assorted Module Binding Function."

Network

Power ON/OFF

Displays a dialog box used to turn ON/OFF the standby power switch of the measuring station. By selecting [All] in the [Station Name] list box and clicking [Power ON] or [Power OFF], you can turn ON/OFF the standby power switch of all the measuring stations that are connected. To turn ON/OFF the standby power switch of a particular measuring station, select the appropriate measuring station in the [Station Name] list box.

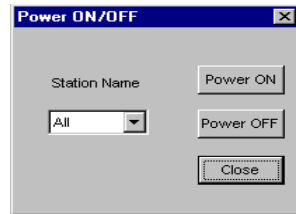

Set Group

When using optical communications or the Ethernet network, the maximum number of measuring station that a single PC can control is three. If there are multiple PCs and measuring stations within a single network such as when connecting to an Ethernet network, you must specify which PCs will control each measuring station by assigning groups. If there are multiple PCs in the same group, multiple PCs will be able to control each station. This can lead to problems (current version of the software does not allow exclusive control).

If you select "Set Group," a group setting dialog box appears (see the figure on the next page). By factory default, all measuring stations are set to undefined group.

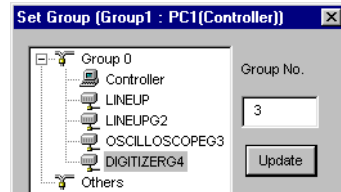

In the group setting dialog box, measuring stations belonging to [Group X] (where X≠0) that were specified by the start parameter of the WE7000 Control Software are shown under [Group X]. Measuring stations belonging to another group without a running PC* and measuring stations belonging to the undefined group are shown under [Others]. If the group number or the PC (controller) is [0], all measuring stations in other inactive PC groups and the undefined group are shown under [Group 0] and nothing is shown under [Others].

* For example, if a PC in "Group 1" is connected, the measuring stations of "Group 1" are displayed only in the group setting dialog box of the PC in "Group 1." They are not displayed in the group setting dialog box of "Group 2."

To set a group, click the measuring station that you wish to set in the group setting dialog box, enter a group number (0 to 32767) in the [Group Number] entry box, and then click the [Update] button. Then, you must reset the main power switch of the measuring station that had its group number changed so that all PCs recognize the new group number.

Note

- You cannot set groups when using USB communication.
- The default group number of a PC (controller) is "0." To change it, you specify it using the start option of the WE7000 Control Software (see "Start Installation" in section 3.2, "Installing the WE7000 Control Software." You cannot change the group number in the group setting dialog box. If you are using optical communications, the start option is specified as "-comm optical devicename= WE7036 GROUPNO=1" (when specifying group 1), for example. Similarly for Ethernet communications, add "GROUPNO=1" to the other start options.

Set IP

The Set IP dialog appears as shown below.

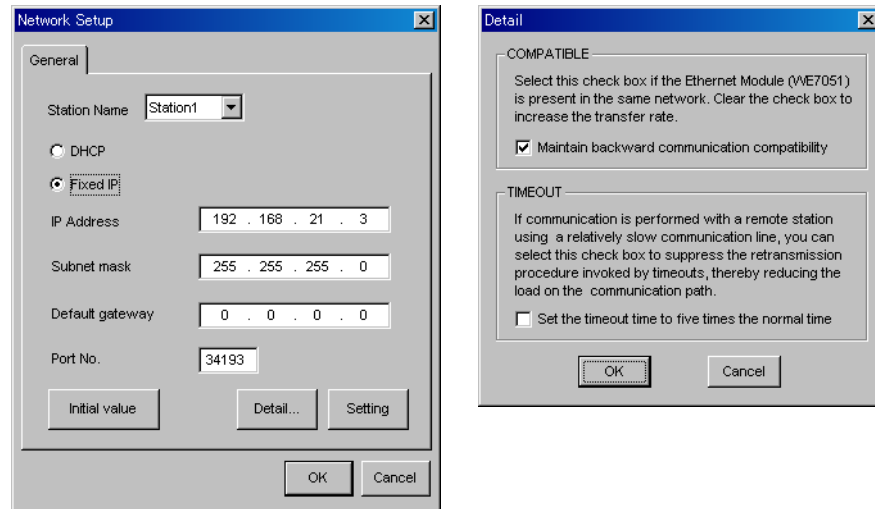

Display the name of the target measuring station in the [Station Name] list box. To use DHCP, select [Obtain an IP address automatically]. To use a fixed IP address, select [Fixed IP]. If [Obtain an IP address automatically] is selected, the assigned IP address is automatically displayed. When using a fixed IP address, set the [IP address], [Subnet mask], [Default gateway], and [Port No.].

If a WE400/WE800 that is performing communication using the WE7052 Ethernet Interface Module exists in the same network, you can select whether to provide compatibility with the WE500/WE900 transfer rate. Click [Detail] and select the [Maintain communication compatibility] check box to synchronize the measuring stations by setting the transfer rate to the slowest measuring station. If you clear the [Maintain communication compatibility] check box, communication is performed at the transfer rate of each measuring station. In this case, you must add "COMPATIBLE=OFF" to the start option (see page 3-9). By default, the [Maintain communication compatibility] check box is selected.

If a low-speed line is used and the load is great, click [Detail] and select the [Set the timeout time to five times the normal time] check box. This will reduce the load on the communication path. By default, the [Set the timeout time to five times the normal time] check box is not selected.

If you click the [Initial value] button, all the network parameters are reset to default values. If you change the settings, click the [Setting] button. If a confirmation dialog box opens, click the [Yes] button. This will restart the measuring station. The new settings are applied when the WE7000 restarts.

Load Hosts File

By creating a host file (file name: hosts.txt) containing IP addresses and station names of measuring stations that are connected outside the segment, you will be able to control those measuring stations. Enter the "IP addresses" in the host file as shown below. Character strings that are placed after a space or tab after the IP address are handled as comments. If you wish to enter a comment from the beginning of the line, enter a "#" at the beginning of the line.

```
# For example:
127.0.0.1
127.0.0.2
```

After creating the host file, select [Load Hosts File] to display the icons of the corresponding measuring stations in the station list window.

Note

- When connected to the Ethernet network, the WE7000 Control Software does not detect the OFF state of the main power switch of measuring stations. If you believe the measuring station control is abnormal, select [Refresh] from the [View] menu and redetect the newest configuration of measuring stations.
- If a measuring station is assigned to another group (see the previous page), it is not controllable, and the icon corresponding to the measuring station does not appear.
- Depending on the network condition, a timeout may occur while loading the host file. In such case, selecting Refresh from the View menu may lead to proper operation.

System

Configuration Settings

Displays a dialog box used to change the configuration settings such as the action to be taken when setup data is saved, the display format of the operation panel, waveform monitor, and dialog box, and the startup operation.

- General

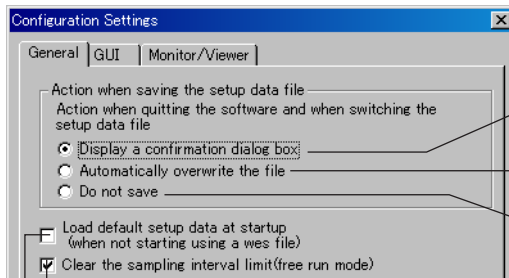

- To display a setup data confirmation dialog box when setup data is lost or changed
- To automatically write the settings to the setup data file
- To close the program without saving the modified setup data

To allow setting the maximum sampling to 100 us in free run mode and display the size of the saved data on the Measured Data Save Operation Monitor

Select this check box when starting the program using the previous setup data (when you closed the program the previous time)

- GUI

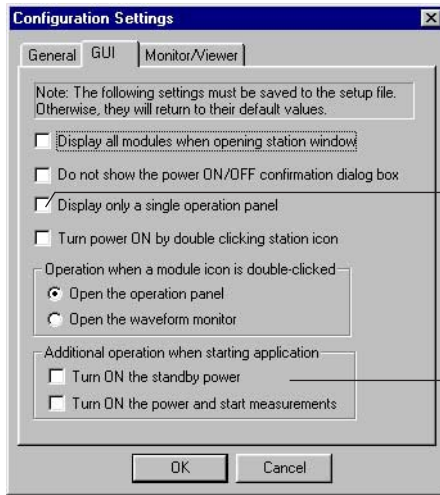

When displaying only one operation panel at any given time (This does not limit the number of operation panels that are displayed in the station window.)

Select these check boxes to turn ON the standby power of the measuring station or start the measurement when the WE7000 Control Software is started.

• Monitor/Viewer

You can change the size of the waveform monitor or viewer when it is displayed. In addition, on the following modules with the indicated software version, you can set the monitor to display the arming signal wait state or the trigger-detected state when the acquisition mode is set to trigger mode.

WE7231 (Ver. 3.05 or later), WE7235 (Ver. 3.01 or later), WE7241 (Ver. 3.15 or later), WE7251 (Ver. 3.05 or later), WE7271/WE7272 (Ver. 3.06 or later), WE7273, WE7275 (Ver. 3.05 or later), WE7521 (Ver. 3.02 or later)

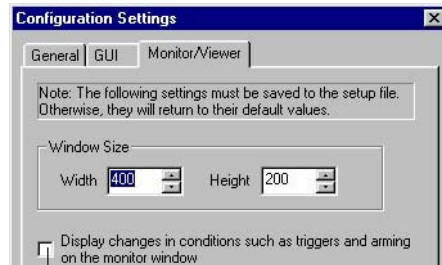

Select the check box when displaying the arming signal wait state or trigger-detected state on the monitor

State display of trigger detection

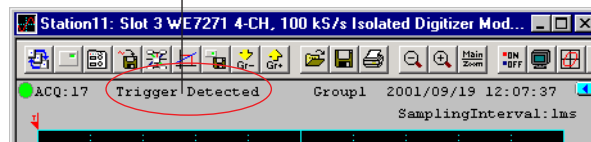

Self Test

Displays the “Self Test” dialog box used to perform self tests on each module. For operations of the [Self Test] dialog box, see section 5.2, “Self Test.”

Global

Power ON/Power OFF

Turns ON/OFF the standby power of all measuring stations that are connected (measuring stations that are displayed in the station list window) at once. You can also carry out the same operation by clicking the [Power ON]/[Power OFF] button shown below.

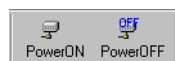

Right-clicking these tool buttons opens a dialog box shown below. This dialog box can be used to select which measuring stations will be turned ON/OFF at once. If you remove the check, it is deselected. Select the measuring stations that are turned ON and OFF at once in each dialog box (dialog boxes are not synchronized). This setting also applies to operations in the menu.

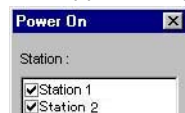

Monitor/Close

Select this menu command to display or close all the waveform monitors that are used to monitor the measured waveforms of each measurement module at once. You can also carry out the same operation by clicking [Monitor]/[Close] shown below.



4.3 Menu Bar Operations

Right-clicking [Monitor] opens a dialog box shown below. This dialog box can be used to select which measuring stations will be affected by the global operation. Select the measuring station in the [Station] list box and remove the check from the measurement module in the [Module] list to deselect the module. Select the measurement modules of which the waveform monitor is to be displayed at once and the modules of which the waveform monitor is to be closed at once in each dialog box (dialog boxes are not synchronized). This setting also applies to operations in the menu.



Arrange

Select this menu command to arrange the menu bar, station list window, and waveform monitors/viewers.

You can also carry out the same operation by clicking [Arrange] shown below. Click the arrow on the right of the button to display a menu for selecting the arrangement method.



Start/Stop

Select this menu command when starting or stopping the measurement of all measurement modules or the waveform output of all output modules at once. You can also carry out the same operation by clicking [Start]/[Stop] shown below.



Right-clicking these tool buttons opens a dialog box shown below. This dialog box can be used to select which measuring stations will be affected by the global operation. Select the measuring station in the [Station] list box and remove the check from the measurement module in the [Module] list to deselect the module.

The modules that have arming activated (see section 4.6, "Setting the Trigger Source/ Time Base Source/Arming") are the ones that are applicable for global operation in the [Enable ARM] check box. This setting also applies to operations in the menu.



Note

Start/Stop operation of all waveform output at once is valid only on the following modules with the indicated software version.

WE7121 (Ver. 3.05 or later) and WE7281/WE7282 (Ver. 3.15 or later).

Trigger Setting

Select this menu command when displaying the trigger source/time base source/arming setting dialog box of all measuring stations at once. For the operations of the trigger source/time base source/arming setting dialog box, see section 4.6, "Setting the Trigger Source/Time Base Source/Arming."

You can also carry out the same operation by clicking the [Trigger] button shown below.



Right-clicking the tool button opens a dialog box shown below. This dialog box is used to select the measuring stations of which the trigger source/time base source/arming setting dialog box is to be displayed at once. If you remove the check, it is deselected. This setting also applies to operations in the menu.

**Generate Bus Trigger1 Signal/Generate Bus Trigger2 Signal**

Select this menu command when applying a manual arming signal (one shot signal) to either of the buses, bus trigger signal [BUSTRG1 or BUSTRG2]. For details on the bus trigger signal [BUSTRG1 and BUSTRG2], see section 4.6, "Setting the Trigger Source/Time Base Source/Arming."

You can also carry out the same operation by clicking the [TRG1]/[TRG2] button shown below. Clicking the button once causes the button to remain in the depressed state and manual trigger is turned ON. Clicking it another time causes the button to return to the original position and manual trigger is turned OFF. Clicking the arrow on the right of the button and selecting [One Shot] generates a single shot bus trigger signal.

**Note**

The operation described above and the operation of the manual trigger signal generation button in the trigger source/time base source/arming setting dialog box are the same operation, but the ON/OFF condition of the button is not synchronized. However, if the trigger source/time base source/arming setting dialog box is displayed after operating the buttons on the menu bar, they will be set to the same ON/OFF condition.

Generate Arming Signal

This menu command is used to apply a manual arming signal to the arming signal bus. For details on the arming signal [ARM], see section 4.6, "Setting the Trigger Source/Time Base Source/Arming." You can also carry out the same operation by clicking the [ARM] button shown below.

**Help****WE7000 Help**

Acrobat Reader starts and help is displayed. You can also carry out the same operation by clicking the [Help] button shown below.

**Version**

Displays the version of the WE7000 Control Software.

Start/Stop Save Operation Button

Click these buttons when starting or stopping the saving of waveform data. This operation is also possible when [Start/Stop saving of measured data] is selected from the menu that appears by right-clicking on the waveform monitor or clicking the [Start/Stop saving of measured data] button. For details on saving the waveform data, see section 4.8, "Saving Waveform Data/Converting Files." For details on the waveform monitor, see section 4.7, "Displaying the Waveform Monitor and Viewer."

Right-clicking these tool buttons opens a dialog box shown below. This dialog box can be used to select which measuring stations will be affected by the global operation. Select the measuring station in the [Station] list box and remove the check from the measurement module in the [Module] list to deselect the module.



4.4 Station List Window Operations

This section describes the operations of the station list window that appears/closes by clicking the [Station] button on the menu bar or by selecting [Station List Window] from the [View] menu.

Switching the Display Format

By default, the controller, station, and module icons are displayed in a tree structure when the WE7000 Control Software is started. In the tree structure display, you can drag and drop the module icon to copy the setup data between modules. If you double-click the station icon, the module icons disappear. If you double-click the station icon, the module icons disappear.

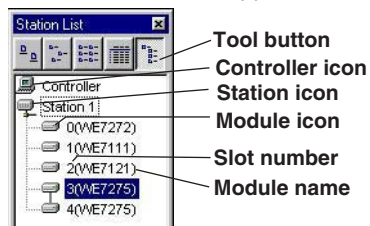

Other display formats

By clicking the tool button, you can switch the display format as shown below.



- Details

Displays comments that can be entered in the station properties, IP addresses in the address column, "Power OFF," " (standby power switch OFF) "Fan Stop," etc. in the [Status] column and other information according to the conditions of the measuring station.

Station	Address	Status	Comment
Controller	0 (10.0.232.204)		
Station 1	1 (10.0.233.94)		Test 2

Pop-up Menu of the Controller Icon

Right-clicking the controller icon displays the following menu.

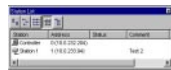

Properties

Displays the Controller Property dialog box. When communications are carried out via the optical interface, the information (product ID, software version, and product name) about the optical interface card that is installed in the PC is displayed. When connected to the Ethernet network, Ethernet-related information such as software version and product name (Standard Ethernet) is displayed. When communications are carried out via the serial communication interface, the model name of the serial interface cable is displayed.



Pop-up Menu of the Station Icon

Right-clicking the station icon displays the following menu.



If multiple measuring stations are selected and then right-clicked, only Power ON/Power OFF, Restart, Generate Arming Signal, Generate Bus Trigger1 Signal, and Generate Bus Trigger2 Signal are displayed.

Open

Opens the station window. If the standby power is OFF, the power is first turned ON, and then the station window is opened. For the displayed contents and operations on the station window, see section 4.5, “Displaying the Station Window and Operations on the Station Window.”

Power ON/Power OFF/Restart

See section 4.1, “Turning the Measuring Station ON/OFF and Restarting.”

Rename

See section 4.2, “Changing the Name of Controller/Measuring Station and Entering Comments.”

Properties

The following property dialog box is displayed. You can change the name of the measuring station (station name) and enter comments in this dialog box.

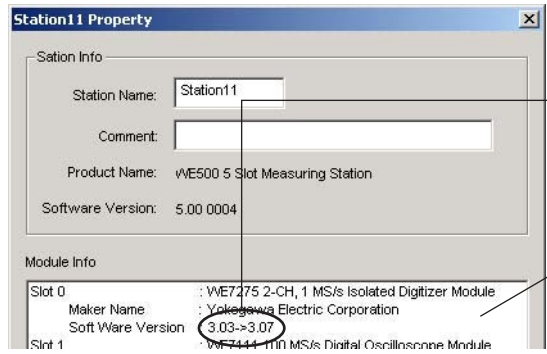

If the same type of modules with different software versions is installed in the measuring station, the newest version among the installed module is used for operation.

Displays product name, version number, etc. (If a malfunction occurs, quote the version number that is displayed here.)

Update Preset Values/Initialize Preset Values/Execute Preset Values/Execute Default/Save Setup Data/Load Setup Data/Display Setup Data

Modifies the setup data of all measurement modules that are installed in the measuring station of which the menu is displayed.

- Update Preset: Store the current settings (preset values are used in place of values existing immediately before turning OFF the power, when the measuring station is turned ON the next time. However, if you open the WE7000 Control Software using the setup data file or change the settings using the setup data file, settings will take on the values as specified by the setup data file not the preset values.)
- Initialize Preset: Replace preset values with default values
- Execute Preset: Replace current settings with preset values
- Execute Default: Replace current settings with default values
- Save Setup Data: Save the setup data to a file.
- Load Setup Data: Load the setup data from a file, and change the current settings.
- Display Setup Data: List the setup data

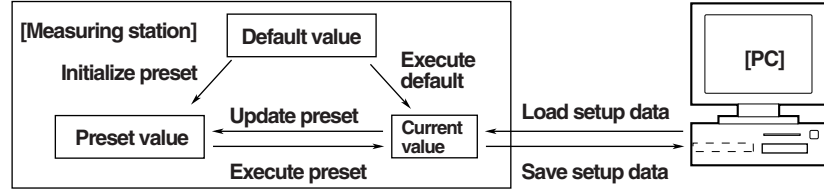

When loading the setup data, the modules must be in the same slot as when the setup data were saved. Selecting a file (extension: .set) from the dialog box will display slot information as shown in the figure below. Verify the information before loading the file. If a different module is installed, an “No” is displayed. If you load the file when there are “No” indications only the setup data of measurement modules which have not moved will be loaded (Slots indicated as “Yes”).

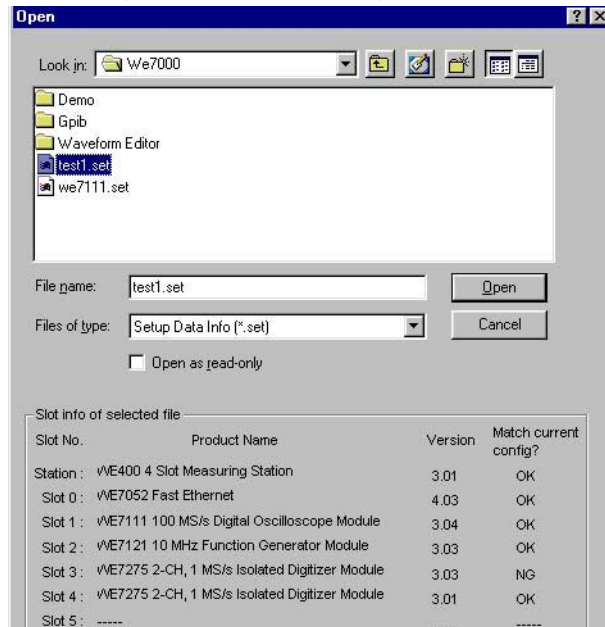

Selecting [Display Setup Data] displays a dialog box that shows a list of setup data for all the modules (except the communication module) of the specific measuring station (see below). Clicking the [Save] button displays a dialog box for saving the setup data to a text file.

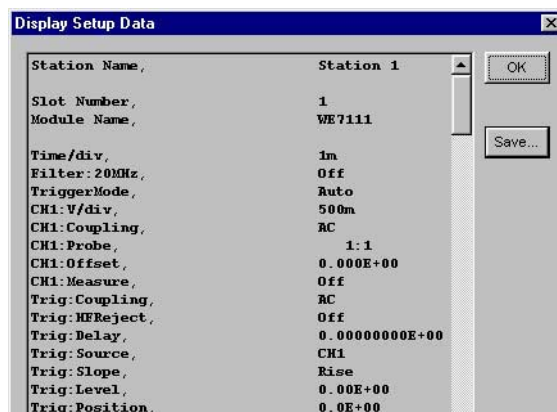

Trigger Setting/Generate Arming Signal/Start all armed modules/Stop all armed modules/Generate Bus Trigger1 Signal/Generate Bus Trigger2 Signal

See section 4.6, “Setting the Trigger Source/Time Base Source/Arming.”

Station Help

Acrobat Reader starts and help regarding the displayed contents and operations on the station window is displayed.

Pop-up Menu of the Module Icon

Right-clicking the module icon displays the following menu. However, the menu is not displayed for the communication module icon.



Open operation panel

Opens the operation panel of each module. You can also double-click the module icon to open the operation panel. If the [Display only a single operation panel] check box in the [Configuration Settings] of the [System] menu of the main menu is selected, only one operation panel is displayed at any given time.

Open monitor panel

On modules that display measured values on the operation panel such as the 100 MHz Universal Counter Module, a monitor panel is displayed instead of the operation panel.

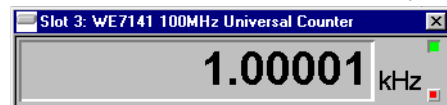

Update Preset Values/Initialize Preset Values/Execute Preset Values/Execute Default/Save Setup Data/Load Setup Data/Display Setup Data

You can perform the following operations on the setup data for the measurement module that is displaying the menu.

- Update Preset: Store the current settings (preset values are used in place of values existing immediately before turning OFF the power, when the measuring station is turned ON the next time. However, if you open the WE7000 Control Software using the setup data file or change the settings using the setup data file, settings will take on the values as specified by the setup data file not the preset values.)
- Initialize Preset: Replace preset values with default values
- Execute Preset: Replace current settings with preset values
- Execute Default: Replace current settings with default values
- Save Setup Data: Save the setup data to a file.
- Load Setup Data: Load the setup data from a file, and change the current settings.
- Display Setup Data: List the setup data

Selecting a file from the dialog box that appears by selecting [Load Setup Data] will display slot information as shown in the figure below. Verify the information before loading the file. If the measurement modules are linked, you can remove the check from the [Load Setup Data] check box to load the data only to the specified measurement module.

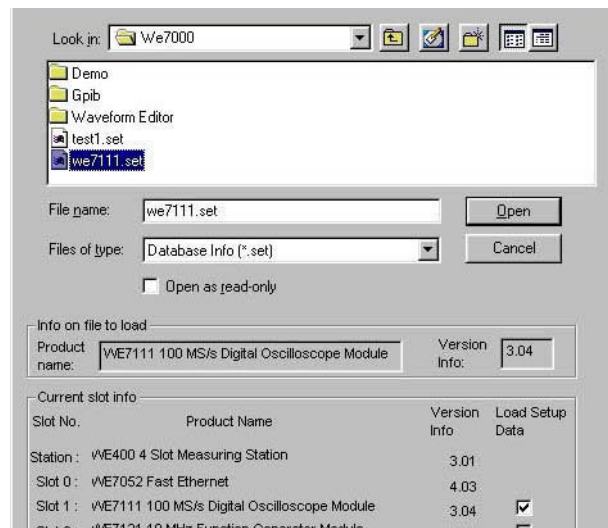

Selecting [Copy Setup Data] displays a dialog box as shown in the figure below, in which setup data can be copied between the same type of measurement modules. By entering the name of the measuring station (Station Name) and the slot number containing the destination measurement module, setup data is then copied by clicking the [OK] button. If you specify [*] (an asterisk) for the module number, the setup data are copied to all measurement modules of the same type as the copy source module. If you wish to copy the setup data to all modules of the same type on all measuring stations, enter [*] (asterisk) in both the station name and the slot number. On modules that have multiple channel settings (includes multiple channels created by linked modules), you can select [Copy between channels] from the menu. In the dialog box that appears, you can copy setup data between channels.

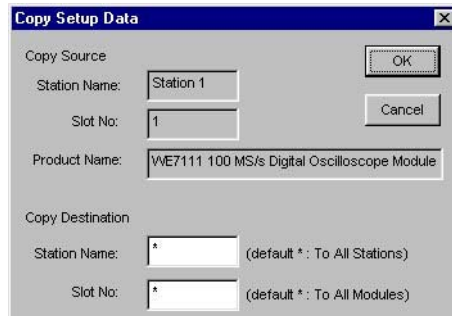

Selecting [Display Setup Data] displays a dialog box that shows a list of setup data of the specified module (see below). Clicking the [Save] button displays a dialog box for saving the setup data to a text file.

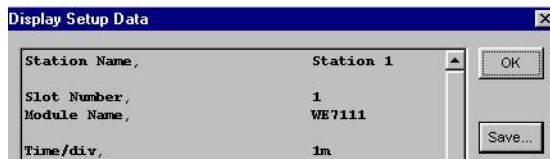

Note

- You can also copy the setup data between measurement modules by dragging & dropping the module icon.
- If the modules are linked, only the setup data with the smallest module number are saved. This is also true when copying the setup data.
- To save the setup data of all of the linked modules, save the setup data of all modules in the dialog box that appears by selecting “Save Setup Data” in the station menu.

Save Acquisition Data

Displays a dialog box used to save the acquired data. For the operations of the dialog box, see section 4.8, “Saving Waveform Data/Converting Files.”

Open Monitor

Displays a waveform monitor used to monitor the waveform data. For the operations of waveform monitor, see the on-line help.

Display Update Rate

Displays a dialog box used to set the display update rate of the waveform viewer when acquiring the waveform data in the free run mode in each module. When a module that is acquiring waveform data at high speeds is active, the performance improves by lowering the display update rate.

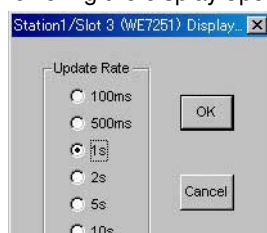

4.4 Station List Window Operation

Convert Scale

On modules that can scale the measured data, a dialog box used to linearly convert the measured values to user-specified physical values appears. On modules that cannot scale the measured data, a dialog box used to set only the LABEL appears. Set the measured values at any two points (VP1 and VP2) and their corresponding physical values (SP1 and SP2) or set [a] and [b] of the scale conversion equation ($y=ax+b$) to convert the measured values to arbitrary physical values. The scaled values are applied to the displayed waveform and the waveform data that is saved.

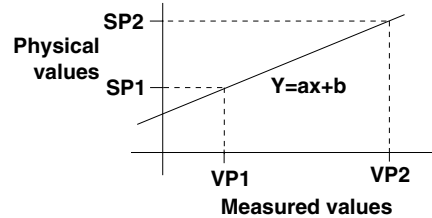

If you wish to save the measured data using scaled values, select the [Save Physical Values] check box and enable scale conversion. Then, set the scale values (VP1, SP1, VP2, SP2 or a, b). If you do not select the [Save Physical Values] check box, the waveform display will be converted, but raw data will be saved to the file.

Set the LABEL and UNIT as necessary (spaces are not allowed). The label and unit are applied to the waveform display and in the saved measurement data. The channel number is displayed, if the label is not assigned or the Label Display check box is cleared in the menu that appears by right-clicking on the waveform monitor.

To select a single channel for copy and paste, click [CHx]. To select multiple channels, drag the mouse on the [CHx] buttons. To select all the channels, click the [No.] button.

Enable/Disable scale conversion Set the unit (up to 15 characters)

Set the label (up to 31 characters)

P1- P2 Set the scale values

aX+b Set the scale values

Select/Deselect all channels

Select/Deselect a channel (Select multiple channels by dragging the mouse)

Paste one column of item (paste the setting of the first channel in the selected range to the other selected channels)

Save with physical values

Paste the copied information to the selected channels

Enable/Disable the scale conversion on the selected channels at once

Copy the settings of the selected channels

Display the copy item selection dialog box

No.	Label	On	Unit	VP1	SP1	VP2	SP2	a	b
CH1	kg	<input checked="" type="checkbox"/>		0.000E0	0.000E0	1.000E0	1.000E0	1.000E0	0.000E0
CH2	Frequency	<input type="checkbox"/>		0.000E0	0.000E0	1.000E0	1.000E0	1.000E0	0.000E0
CH3		<input type="checkbox"/>		0.000E0	0.000E0	1.000E0	1.000E0	1.000E0	0.000E0
CH4		<input type="checkbox"/>		0.000E0	0.000E0	1.000E0	1.000E0	1.000E0	0.000E0

Module Help

Acrobat Reader starts and help regarding the module menu is displayed.

Pop-up Menu in the Station List Window

Right-clicking the white space on the station list window displays the following menu.



When you click this menu, the following dialog box opens.

You can specify how the station list window and station window are displayed.

Always on top: Select this check box if you wish to display the station list window always on top. This facilitates calling of the setup screens of various modules.

Auto hide: Select this check box to automatically hide the station list window from the screen after showing the station window. This feature enables efficient use of the screen even on small displays.



4.5 Displaying the Station Window and Operations on the Station Window

Selecting [Open] in the menu that appears by right-clicking the station icon displays a station window as shown in the figure below. An operation panel for the measurement module is displayed within the station window as shown in the figure. Only the operation panel of the measurement module with the smallest slot number is displayed as default. If you wish to display the operation panel of other measurement modules, double-click the module icon displayed on the left edge of the window.

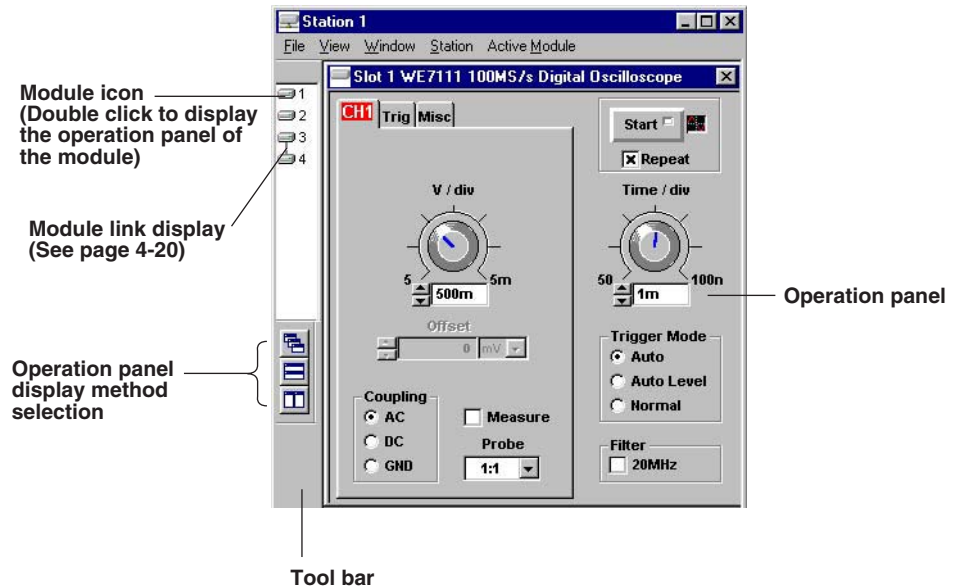

File Menu

Close

Select this menu command when closing the station window

View Menu

Tool Bar

Select this menu command to turn ON/OFF the toolbar.

Window Menu

Cascade

If multiple operation panels are displayed, the panels are arranged in a cascaded fashion. If a single operation panel is displayed, the operation panel is displayed in a full window.

Tile Vertically

If multiple operation panels are displayed, they are aligned vertically on the display. If an panel does not fit in the PC's display, it is moved to the right.

Tile Horizontally

If multiple operation panels are displayed, they are aligned horizontally on the display. If an panel does not fit in the PC's display, it is moved below.

Station Menu

This menu is the same menu that appears when a station icon is right-clicked on the station list window. For details, see page 4-15.

Active Module Menu

This menu is the same menu that appears when a module icon is right-clicked on the station list window. For details, see page 4-17.

4.6 Setting the Trigger Source/Time Base Source/Arming

This section describes the setting procedures for sharing trigger signals, time base signals, and arming signals between multiple modules, and for the exchange of these signals between external devices. How the modules use these signals is determined by the settings in the operation panels of the individual modules. For a detailed explanation of these signals, see section 1.5, "About the Trigger Source/Time Base Source/Arming Settings." For module specific information, see the User's Manual of that module.

Tool Buttons Related to Trigger Source/Time Base Source/Arming

Operation is carried out using the tool buttons on the menu bar (see below), the [Global] menu, or the menu that appears by right-clicking the station icon.

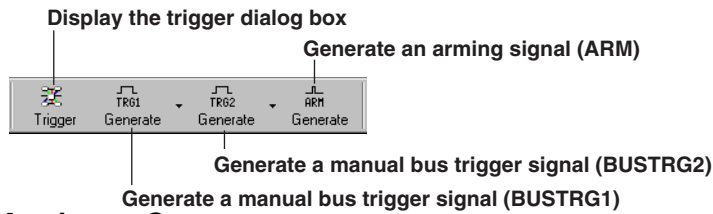

Starting/Stopping Arming at Once

The dialog box that appears by right-clicking the [Start]/[Stop] button on the menu bar has the [Enable ARM] check box. If you select this check box and click [OK], the operation of this button will be the same as clicking the [Start] button on all modules that have arming activated.



Trigger Source/Time Base Source/Arming Setting Dialog Box

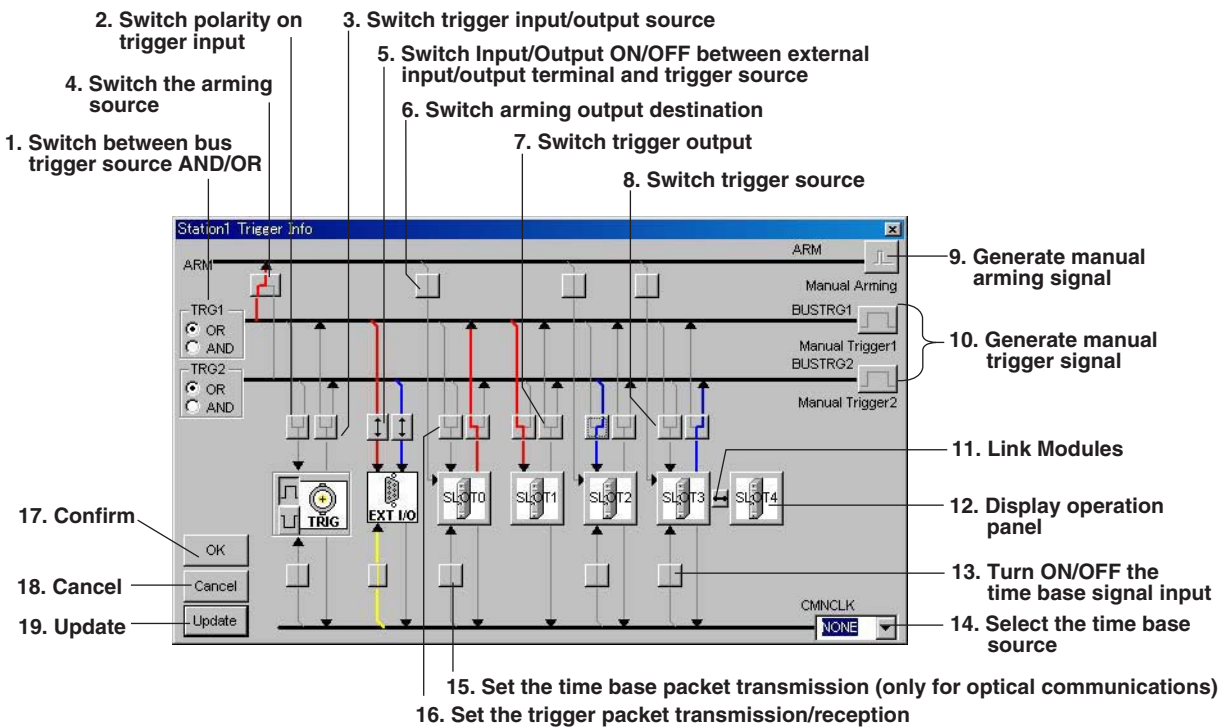

1. **Switch between bus trigger source AND/OR**
 Selects whether to take the AND or OR of the multiple trigger signals of which the result is output to the bus as the bus trigger signal [BUSTRG1, BUSTRG2].
2. **Switch polarity on trigger input/output**
 Sets the polarity on the trigger signal entering at the external trigger input (TRIG).
3. **Switch trigger input/output source**
 Sets which bus trigger signal [BUSTRG1, BUSTRG2] will use the trigger signal input from the external trigger input/output (TRIG).
4. **Switch the arming source**
 Sets the arming signal's (ARM) input source. The input source is the two trigger buses.
5. **Switch Input/Output between external input/output terminal and trigger source**
 Sets the input/output (direction) on the trigger source passing through the external input/output connector (EXT. I/O).
6. **Switch the arming output destination**
 Sets the arming signal's (ARM) output destination. The output destination is the module that can input arming signals.
7. **Switch trigger output**
 Selects whether or not to output the trigger signal from each module and if yes, which bus trigger signal, BUSTRG1, or BUSTRG2, to use.
8. **Switch trigger source**
 Selects whether or not to feed the trigger signal to each module and if yes, which bus trigger signal, BUSTRG1 or BUSTRG2, to use. To use this trigger source on the module, select [BUSTRG] at the trigger setting of each module.
9. **Generate manual arming signal**
 Click to manually generate the arming signal to the arming signal bus.
10. **Generate manual trigger signal**
 This button is clicked to provide a manual trigger signal to either of the bus trigger signals [BUSTRG1, BUSTRG2]. Pressing the button once will set the button in a depressed position and the manual trigger is turned ON. Pressing it again will set the button back to its original position and the manual trigger is turned OFF. On modules that can perform gate operation, selecting the gate mode in the operation panel will make the button operate as manual gate buttons.
11. **Link Modules**
 If modules that can be linked together are installed in adjacent slots, a button for selecting whether or not to link them appears. If the modules are linked, operation under the same setting and synchronized operation are possible. If the link setting is changed, the result is reflected in the operation panel of the modules.

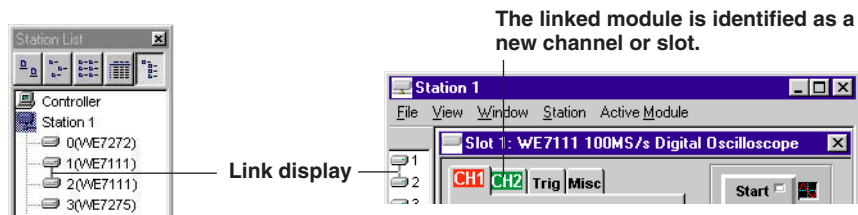

Note
 The maximum number of WE7521 modules that can be linked is 8. If WE7521 is installed in all the slots of the WE900, slot 8 is not linked.

12. Display operation panel

Clicking this button will display the operation panel of the module installed in that slot. The color of this button will turn green when measurement is in progress.



Turns green during measurement

13. Turn ON/OFF the time base signal input

Sets whether or not to provide the time base signal that is generated from the selected time base to each of the modules.

14. Select the time base source

Selects which signal will be used for the time base, when not using the time base signal within the module. You can select a time base input from the external trigger input (TRIG) or the external input/output connector (EXT. I/O) or a time base output [SLOT X] from other modules. When using these time base signals, select [BUSCLK] at the time base setting of the operation window of each module. If you select [SLOT 0], you will be able to receive time base packets from other measuring stations and use them as the time base.

15. Set the time base packet transmission

If you select anything other than [SLOT 0] for the time base source selection, you will select whether or not to transmit time base signal packets to other stations that are connected through the optical interface with a toggle button. You cannot transmit time base packets when connected to the Ethernet network or USB.

16. Set the trigger packet transmission/reception

Sets whether or not to transmit or receive trigger signal packets to other stations that are connected through the optical interface. Each time the button is clicked the setting switches in order, as follows:

- a. Do not transmit or receive trigger packets.
- b. Transmit the trigger packet of bus trigger signal [BUSTRG1].
- c. Transmit the trigger packet of bus trigger signal [BUSTRG2].
- d. Receive the trigger packets as bus trigger signal [BUSTRG1].
- e. Receive the trigger packets as bus trigger signal [BUSTRG2].
- f. Receive the trigger packets as bus trigger signals [BUSTRG1, BUSTRG2]
- g. Transmit the trigger packet of bus trigger signal [BUSTRG1] and receive the trigger packet for bus trigger signal [BUSTRG2].
- h. Transmit the trigger packet of bus trigger signal [BUSTRG2] and receive the trigger packet for bus trigger signal [BUSTRG1].

17. Confirm

Click when setting is complete.

18. Cancel

Click to set the items to their original values.

19. Update

Click to update the setting parameters without closing the dialog box. This button does not become effective until a setting is changed.

Note

The trigger source/time base source/arming settings return to their preset values when the standby power switch is turned OFF. To save the settings follow the procedures given on page 4-15 or update preset.

4.7 Displaying the Waveform Monitor and Viewer

WE7000 Control Software provides a “Waveform Monitor” used to monitor the acquired waveforms in real-time and a “Viewer” used to load the acquisition data that have been stored and display the waveform.

Waveform Monitor

Turning ON/OFF the monitor

On measurement modules that acquire data, a waveform monitor is displayed when the [Start] button on the operation panel is clicked and the acquisition starts. You can open or close the waveform monitor by clicking the “Waveform monitor ON/OFF” button that is located to the right of the [Start] button.



Turn ON/OFF the waveform monitor

To open all the waveform monitors at once, select [Monitor] from the [Global] menu. To close all the waveform monitors at once, select [Close] from the [Global] menu. You can also carry out the same operation by clicking the [Monitor]/[Close] button shown below.



Right-clicking these tool buttons opens a dialog box shown below. This dialog box can be used to select which measuring stations will be affected by the global operation.

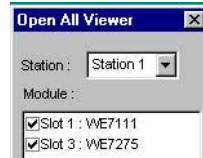

Waveform display example

For the 100 MS/s Digital Oscilloscope Module (WE7111)

The screenshot shows the main interface of the WE7000 Control Software. The top toolbar contains various icons for file operations, measurement, and display control. The main display area is divided into two sections: a top section showing a high-frequency waveform (1ms/div) and a bottom section showing a zoomed-in view of a portion of the waveform (200us/div). The zoomed-in view includes a red cursor and measurement data.

Callouts on the left side include: Customize toolbar, Start/stop measurement, Display operation panel, Set waveform data save, Set trigger, Set label, Acquisition count, Measurement start/stop indicator, Axis information display area ON/OFF, Trigger position, Ground level, Trigger level, Measurement information display area ON/OFF, Vertical sensitivity, and Cursor measurement values.

Callouts on the right side include: Display saved waveform, Save displayed waveform, Switch main/zoom display, Set color, Set display, Switch T-Y/X-Y display, Switch full screen/split screen, Delete displayed waveform, Set ON/OFF of waveform/cursor/measured values, Snap shot, List measured waveform parameter values, Copy to clipboard, Show help, Date and time, Time axis, Main waveform display frame, Set zoom range, Zoom range, Time axis, Zoom factor, Zoom waveform display frame, and Cursor.

Callouts at the top include: Switch displayed group, Print, Change zoom factor, and Set ON/OFF of waveform/cursor/measured values.

At the bottom, a table displays measurement information:

	X1	X2	dX	
Pos	-725us	765us	1.490ms	
CH1	0.98 V	-0.98 V	Freq	671.0 Hz

For the 2-CH, 1 MS/s Isolated Digitizer Module (WE7275) in the free run mode

Labels on the left side of the screenshot:

- Customize toolbar
- Start/stop measurement
- Open operation panel
- Set waveform data save
- Set trigger
- Set scale conversion
- Measurement start/stop indicator
- Sampling interval
- Axis information display area ON/OFF
- Ground level
- Cursor
- Measurement information display area ON/OFF
- Scaled values
- Cursor measurement values

Labels on the right side of the screenshot:

- Start/stop saving of measured data
- Switch displayed group
- Start/stop voice memo recording
- Display saved waveform
- Save displayed waveform
- Print
- Set color
- Set display
- Switch T-Y/X-Y display
- Switch full screen/split screen
- Delete displayed waveform
- Set ON/OFF of waveform/cursor/measured values
- Snap shot
- List measured waveform parameter values
- Copy to clipboard
- Show help
- Turn OFF instantaneous value display
- When displaying only the instantaneous value
- Date and time
- Display position
- Sampling interval
- Instantaneous value
- Channel number
- Time since the start of measurement
- Measurement information display area

Note

When saving the displayed waveform data after Excel Linking (see the help for the Waveform Monitor), the data transfer to Excel may take a long time depending on the operating environment, if there are many number of measurement channels (for example, 30 ch × 8 slots = 240 ch). In such case, save the data to ASCII data in CSV format and load the data into Excel.

About the operation

For the operations of waveform monitor, see the on-line help. Right-clicking the waveform monitor displays a menu (shown below) with which you can do the same operations that you can do with the buttons on the toolbar.



Note

Some of the menu commands such as [Set Current Value Update Rate] cannot be accessed through the tool buttons.

Viewer

Displaying the viewer

Select [Run Viewer] from the [Tools] menu. Multiple Viewers can be opened. You can also carry out the same operation by clicking the [Viewer] button shown below.



Loading the measured data

1. Click the tool button indicated below on the Viewer.

Load waveform data file



2. In the dialog box that appears, select the measured data you wish to display the waveform of and click [Open].

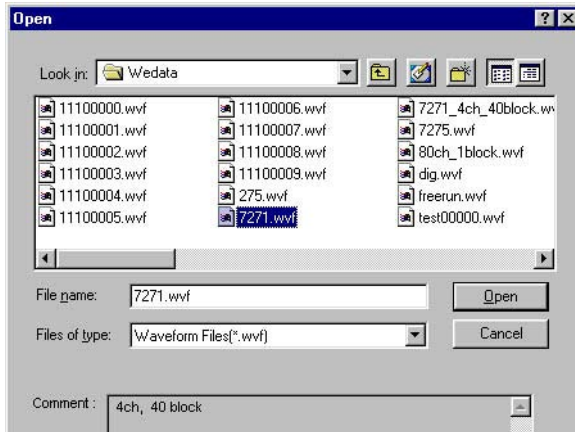

3. In the dialog box that appears, select the waveform to be displayed. To display all waveforms, simply click [Load]. To view a section of the waveform, remove the check mark from the unneeded waveforms.

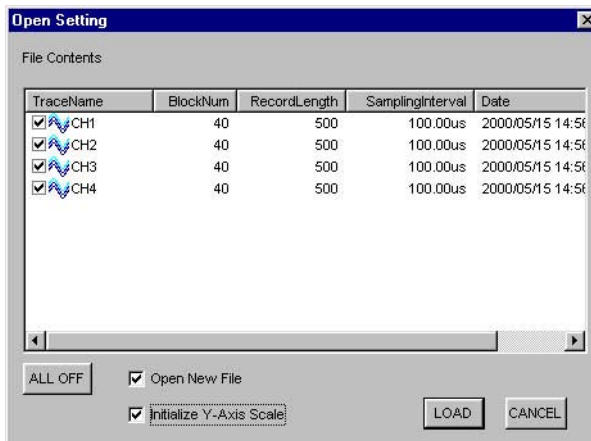

Note

- To display the waveform once and keep the Y-axis display scale when loading another set of measured data, remove the check from the [Initialize Y-Axis Scale] check box. If the [Initialize Y-Axis Scale] is selected, the scale is adjusted according to the displayed waveform.
- If a waveform is already displayed and you wish to load the measured data from another file and add the waveform to the display, remove the check from the [Open New File] check box. However, if the sampling interval, number of blocks, record length or trigger position of the waveform you wish to add to the display is different from that of the waveform that is already displayed, the following error message is displayed, and the waveform cannot be added to the display. The following error message is also displayed, if you attempt to load measured data that contains normal waveform data and FFT-computed waveform data (when using the Computation Function Setup Software).

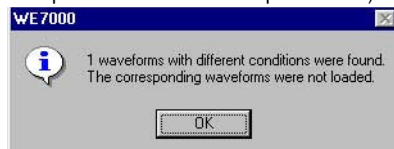

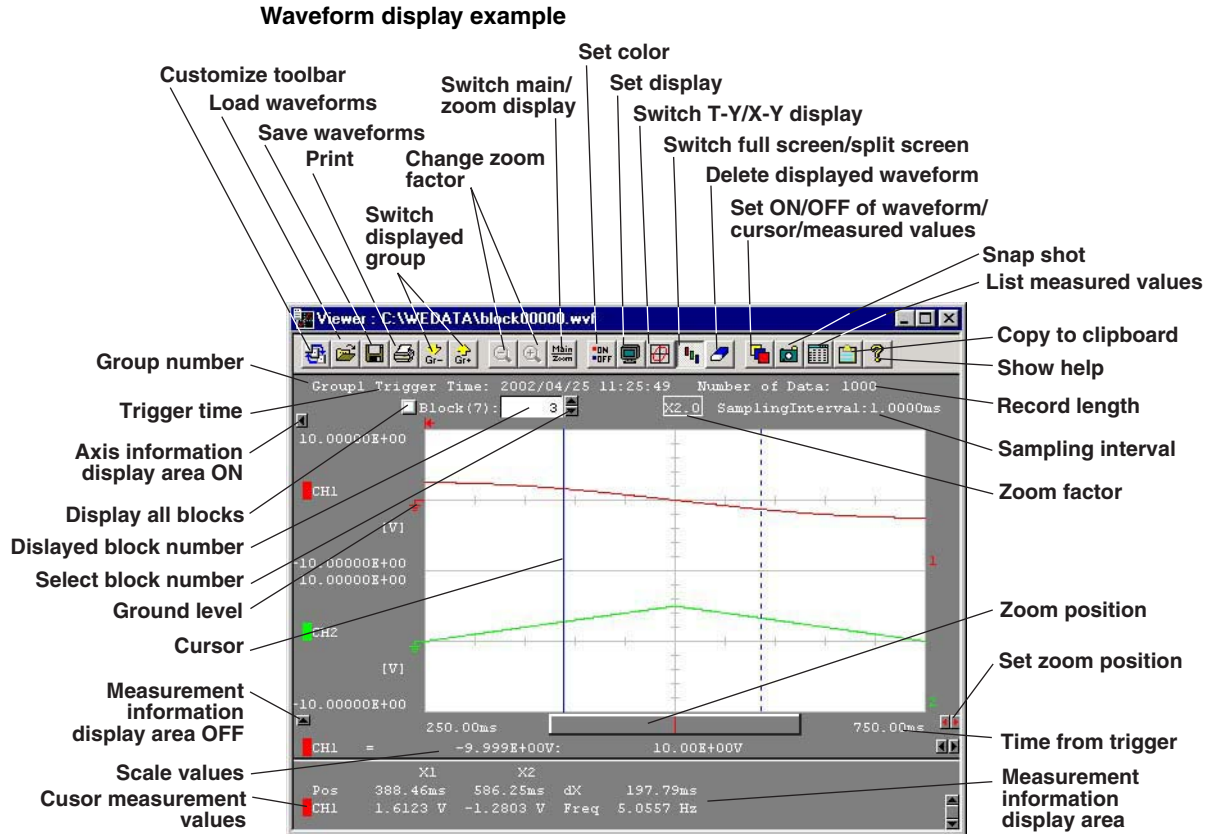

About the operation

For the operations of viewer, see the on-line help. Right-clicking the viewer displays a menu (shown below) with which you can do the same operations that you can do with the buttons on the toolbar.



Note

The waveform label that is displayed for distinguishing scale values is stored if it is specified. However, if you did not specify a label, it is displayed using channel numbers like CH1. Therefore, if you add waveforms to the display and waveforms of same channel numbers exist, their waveform labels can no longer distinguish them. In such case, select [Label Display] and remove the check. When the check is removed, the names of all the waveforms that are displayed are changed to sequential channel numbers.

4.8 Saving Waveform Data/Converting Files

On measurement modules that acquire data, the timing for starting/stopping the saving of the measured data that is displayed on the waveform monitor can be controlled by specifying the time or using triggers. In addition, when measured data is continuously acquired using modules such as the thermometer module, continuous saving of the data is possible.

Limitations

- Controlling of the data save operation by specifying a time is valid on all modules. Trigger control is valid only on the following modules with the indicated software version.
 - WE7231 (Ver. 3.05 or later), WE7235 (Ver. 3.01 or later), WE7241 (Ver. 3.15 or later), WE7245 (Ver. 3.04 or later), WE7251 (Ver. 3.06 or later), WE7271/WE7272 (Ver. 3.07 or later), WE7273 (Ver. 3.01 or later), WE7275 (Ver. 3.07 or later), and WE7521 (Ver. 3.04 or later)
- Save operation using gates is valid only on the following modules with the indicated software version.
 - WE7231 (Ver. 3.05 or later), WE7241 (Ver. 3.15 or later), WE7235 (Ver. 3.05 or later), WE7245 (Ver. 3.05 or later), WE7251 (Ver. 3.08 or later), WE7271/WE7272 (Ver. 3.08 or later), and WE7275 (Ver. 3.08 or later)
- These controls are not available with the GP-IB window function.

Saving Waveform Data

On the station list window, right-click the icon of the module that is to save the measured data or choose [Save Waveform Data] in the [Active Module] menu of the station list window.

In the dialog box that appears, select the conditions for saving the waveform data. Set the conditions on which to save the measured data and click [Start] to transit to the start state for saving the measured data. If you select the [Start saving measured data at the start] check box, the measured data save operation starts according to the specified conditions when measurements are started on each module. Even if the measurement is stopped, the start condition for saving measured data is retained. Therefore, if the measurement is started again, data saving also starts again. To cancel the start condition for saving measured data, click [Stop].

Depending on the setting, you can also start saving the measured data using the following four methods.

- Press the [Start] button on the module's operation panel.
- Select [Start] from the [Global] menu of the menu bar.
- Press the [Start] button on the menu bar.
- Press the [Start/Stop saving of measured data] button on the waveform monitor.

Save the specified number of files of data

Save data in a cyclic pattern within the specified number of files

Enter the save destination/file name

The dialog box contains the following fields and options:

- File Name:** c:\WEDATA\1
- File name number increments each time measurement starts:** (with a Reset button)
- Start condition:** None
- Stop condition:** None
- File save method (valid only during free run mode):** One File
- Save Method:** Cyclic, Limit Number of Files
- File Type:** Binary, Ascii (with Include Time Axis Information checkbox)
- Number of Files:** 10
- File Name Start Number:** 0
- Header(On Every File):** (with a comment box below)
- Overwrite:**
- Start saving measured data at the start:**
- Sound recording method:** Manual
- Buttons:** Start, Stop, OK, Cancel

Callouts and instructions for the dialog box:

- Select the destination folder
- When incrementing the file name number when saving of the measured data is restarted after it is suspended
- Reset the incremented file number
- Select the conditions for starting the saving of the measured data
- Select the conditions for stopping the saving of the measured data
- Select the file save method during free run mode
- Select the file format for the saved data
- When time axis data are needed when saving to ASCII format
- When specifying the start number of the file name
- Enable overwriting to the same file name
- Enable the save operation using the settings
- Start the save operation when measurement is started
- Stop the save operation
- Keep the settings without starting the save operation and close
- Cancel settings
- Select the method of recording the voice memo
- Enter comments for the header file
- When creating a header file for each data file
- Specify the number of files (1 to 65535)

File Name

Enter the base file name and folder for the saved data. The actual file name is “Base file name + file number (00000 to 99999) + extension (.wvf).” The file number is the specified number of files and is assigned in order. For example, if the base file name is “TEST” and the specified number of files is “5,” then the file names are “TEST00000.wvf” to “TEST00004.wvf.” If you wish to change the starting number, enter the number in the [File Name Start] entry box. If you do not specify a folder, a file is created in the current folder at the start of the measurement. However, file numbers are not attached to the names if you do not segment the files when making measurements in the free run mode.

If you wish to continue the numbering of the file name number when the saving of the measured data is restarted after it is suspended, select the [File name number increments each time measurement starts] check box. However, this setting is valid only when making measurements in the free run mode, with the file save method set to [One File] or [Divide by points]. Click the [Reset] button to reset the file name number.

Start Condition/Stop Condition for Saving Waveform Data

Set the save conditions for waveform data using start condition and stop condition.

- Start condition
 - Time: Set the condition for starting the save operation using year, month, day, and time. Selectable also in trigger mode.
 - Trigger (Alarm): Start the save operation when a trigger (alarm for modules that have the alarm function) is detected. You can also set the number of pretrigger points.
 - Gate: Saves the data between gates. The save operation is performed according to the condition selected in [File save method].
 - None: Start saving the data when the [Start] button is clicked or when measurement is started.
- Stop condition
 - Time: Set the condition for stopping the save operation using year, month, day, and time. Selectable also in trigger mode.
 - Trigger (Alarm): Stop the save operation when a trigger (alarm for modules that have the alarm function) is detected. Selectable when the start condition is set to some setting other than [Trigger (Alarm)].
 - None: Stop saving the data when the [Stop] button is clicked or when measurement is stopped.

Note

The function determines the current date and time based on those set on the PC. Make sure your PC's calendar and clock are set correctly.

File Save Method in Free Run Mode

To continuously acquire waveform data or save data to multiple files, select the save method from the following conditions.

- 1 file: Save the data to a single file.
 - Divide by points: Specify the number of data points to be saved and save to multiple files.
 - Time intervals: Specify the number of data points to be saved and the save interval and save to multiple files.
 - Every trigger: Specify the number of data points to be saved and the number of pretrigger points and save to multiple files.
 - Every gate: Save to a separate file for each gate.
- When saving to multiple files, the method specified by [Save Method] is used.

Time Control of Waveform Data Saving

• **Starting the save operation from the specified time**

Set [Start condition] to [Time]. The setting is allowed even when the acquisition mode is set to trigger mode. When [Time] is selected, a list box used to specify the time for starting the save operation is displayed. Enter the year, month, day, and time when the save operation is to be started.

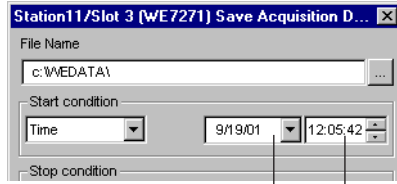

Enter the year, month, day, and time when the save operation is to be started

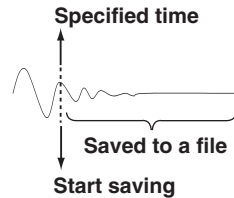

• **Stopping the save operation at the specified time**

Set [Stop condition] to [Time]. The setting is allowed even when the acquisition mode is set to trigger mode. When [Time] is selected, a list box used to specify the time for stopping the save operation is displayed. Enter the year, month, day, and time when the save operation is to be stopped.

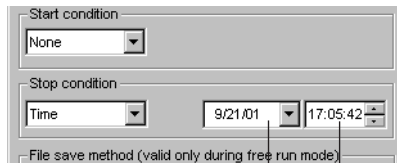

Enter the year, month, day, and time when the save operation is to be stopped

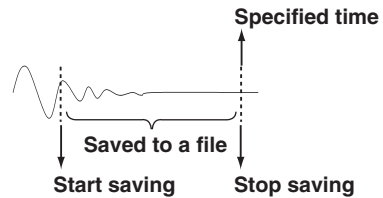

• **Saving at constant intervals**

• Saving data between intervals

Set [File save method] to [Time] intervals. Enter "0" in [Data Points/CH] and the interval for saving the data in [Time intervals] to save the waveform data at specified intervals.

Enter "0" to save the data regardless of the number of data points

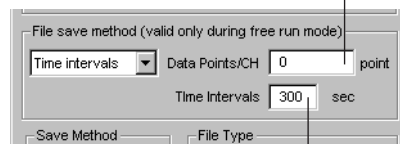

Enter the interval for saving the data

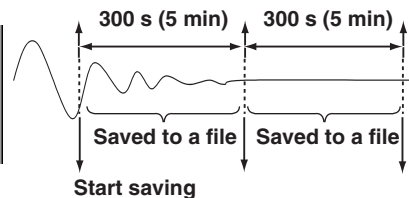

• Saving the specified number of data points between intervals

Set [File save method] to [Time intervals]. Enter the number of data points to be saved per channel in [Data Points/CH] and the interval for saving the data in [Time intervals]. The specified number of waveform data points are saved at specified intervals.

Number of data points to be saved per channel

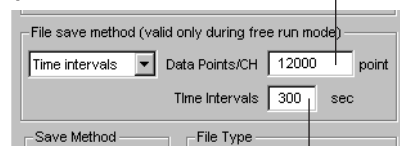

Enter the interval for saving the data

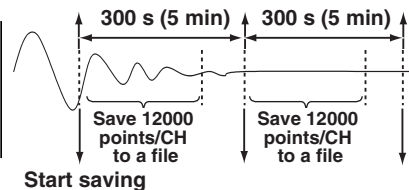

Trigger Control of Waveform Data Saving

• **Starting the save operation using triggers**

Set [Start condition] to [Trigger (Alarm)]. Specify the pretrigger amount in [Pre Trigger/CH]. The data from the specified number of pretrigger points are saved according to the method specified by [File save method].

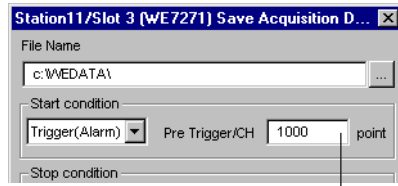

Enter the number of pretrigger points

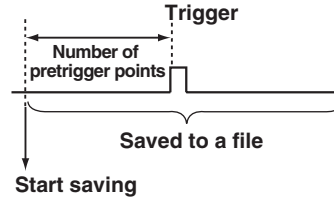

Note

- The actual number of pretrigger points that is saved may be larger than the specified number.
- If a trigger occurs before acquiring the specified number of pretrigger points, the pretrigger data acquired up to that point is held and the save operation is performed.
- On the WE7235, WE7245, WE7251, WE7271/WE7272, WE7275, and WE7521 modules, the interval over which the trigger is detected is specified on the operation panel of the module. To discard trigger detection for a certain time after starting measurements, specify that interval using a "pretrigger." To discard trigger detection for a certain time after the previous trigger, specify that interval using a "hold off."

• **Stopping the save operation using triggers**

Set [Start condition] to some setting other than [Trigger (Alarm)]. Set [Stop condition] to [Trigger (Alarm)]. The save operation starts according to the method specified by [Start condition] and stops when a trigger occurs.

Select some setting other than [Trigger(Alarm)]

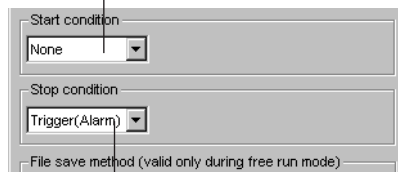

Select [Trigger(Alarm)]

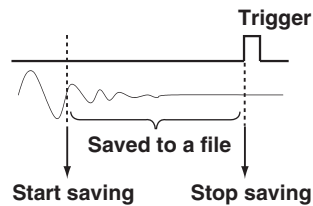

• **Saving Data Every Trigger**

• Saving data between triggers

Set [Start condition] and [Stop condition] to some setting other than [Trigger (Alarm)]. Set [File save method] to [Every trigger]. Enter "0" in [Data Points/CH] and specify the pretrigger amount to be saved in [Pre Trigger/CH] in terms of points. The data after the specified number of pretrigger points are saved every trigger occurrence according to the method specified by [File save method].

Enter "0" to save the data regardless of the number of data points

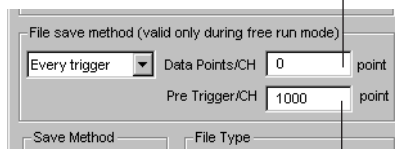

Enter the number of pretrigger points

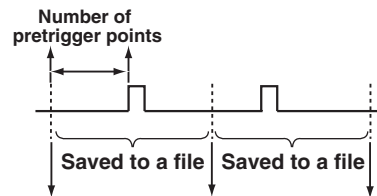

- Saving data by specifying the number of data points
 Set [Start condition] and [Stop condition] to some setting other than [Trigger (Alarm)]. Set [File save method] to [Every trigger]. Enter the number of data points to be saved per channel in [Data Points/CH] and specify the pretrigger amount to be saved in [Pre Trigger/CH] in terms of points. The measured data is saved to individual files every number of data points to be saved including the specified number of pretrigger points.

Enter the number of data points to be saved per data file

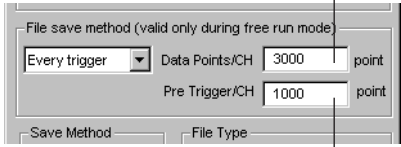

Enter the number of pretrigger points

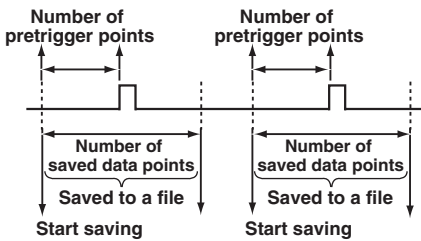

Gate Control of Waveform Data Saving

- **Starting the save operation using gates**

Set [Start condition] to [Gate]. After the save operation is started, data is saved according to the method specified by [File save method].

Select [Gate]

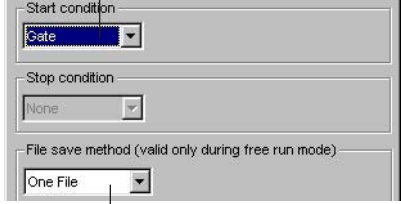

Specify the behavior after the save operation is started

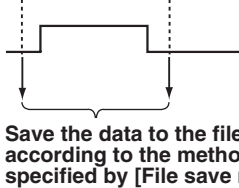

Note

To start the save operation using gates, you must specify High, Low, In, or Out for the module's trigger (alarm) type.

- **Saving data on every gate (only during free run mode)**

Set [Start condition] and [Stop condition] to [None] or [Time]. Set [File save method] to [Every gate].

Select [None] or [Time]

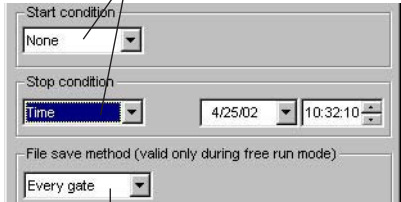

Select [Every gate]

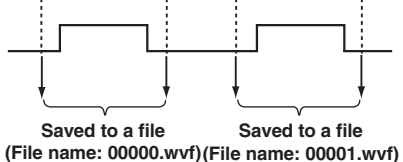

When using gate control, waveform data and voice data (voice memo) can be saved to a single file.

- **Saving voice memo on every gate (only during free run mode)**

Set [Sound recording method] to [Every gate].

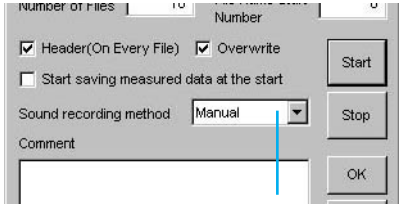

Select [Every Gate]

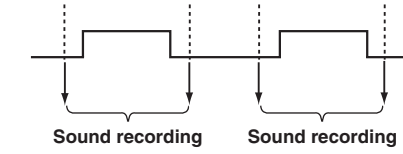

Selecting the File Format for the Saved Data

Select ASCII data in CSV format or binary data in YOKOGAWA's proprietary file format (file extension: .wvf). The file size is smaller for the binary data. When saving to ASCII data, you can select whether to add time axis data. However, if the start/stop condition is set to [Trigger (Alarm)] or the [File save method] is set to [Every Trigger], you cannot save to ASCII Data.

In addition, a header file (extension: .hd1) containing information needed in analyzing the saved data, is created when the waveform data is being saved. This header file is in ASCII format. For details, request for technical information.

Setting Save Method

Select from the following two choices.

- Cyclic

You specify the number of files and the data are saved in a cyclic fashion among the specified number of files until the measurement is stopped. The newest data exits in the file to which the data was saved immediately before the measurement stopped.

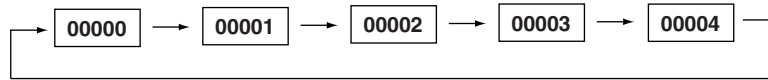

- File number limit

The saving operation stops after saving the data to the specified number of files.

You also select whether to create a header file for each data file or create one header file common to all data files.

Setting the Save Method During Free Run Mode

When continuously acquiring waveform data as when using a thermometer module, select whether to save the data to one file or divide the data among multiple files according to the specified number of data points. When saving to multiple files, set the number of files you are going to save. Also, set the specified number of data points for each file to the number of data points per channel.

When saving to multiple files, the save operation stops upon saving data to the specified number of files.

Starting/Stopping the Save Operation and Setting Waveform Monitor ON/OFF

The save operation starts upon starting the measurement (clicking [Start] on the operation panel, selecting [Start] from the [Global] menu of the menu bar), clicking [Start] on the menu bar, or clicking [Start/Stop saving of measured data] on the waveform monitor. If the measurement is stopped, the save operation is temporarily suspended. But if the measurement is started again, the save operation also resumes.

To stop the save operation, click the [Stop] button on the operation panel, select [Stop] from the [Global] menu of the menu bar, click the [Stop] button on the menu bar, or click [Start/Stop saving of measured data] on the waveform monitor.

Normally, the waveform monitor is displayed when the measurement is started. However, displaying the waveform while saving the waveform data causes the waveform acquisition period to be longer. If you wish to prevent the acquisition period from degrading, set the [Waveform monitor ON/OFF] button, located to the right of the [Start] button on the operation panel, to the OFF setting.



Waveform monitor ON/OFF button

Monitoring the Save Operation of Measured Data

If the Measured Data Save Operation Monitor check box is selected in the View menu, a monitor window appears when the save operation of the measured data starts. You can confirm the save status of the measured data in this window. As shown in the following figure, the name of the measuring station saving the data, the slot No. and module name, the file name, the number of measurements, the save status of the measured data (Saving, Stopped, Waiting for trigger, and Waiting for time), and so on are displayed in the monitor window.

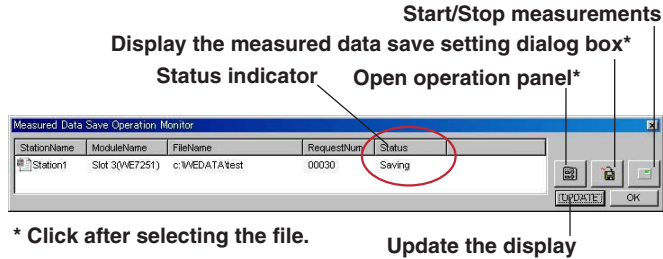

- When the [Clear the sampling interval limit (free run mode)] check box is selected in [Configuration Settings] > [General]

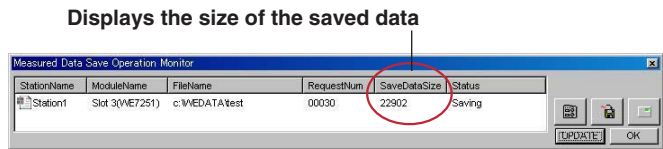

Converting Files

Waveform data that are saved in binary format can be converted to ASCII data in CSV format (*.csv) or to a physical value in 32-bit floating point format (conforming to IEEE754-1985) (*.wvf). To convert the file, select [Convert File] from the [Tools] menu of the menu bar.

In the displayed dialog box below, select the waveform data file to convert, the destination of the converted data file (folder and file name), and the conversion method. In addition, check [Segment Files at 64 K] if you need to segment the files such as when using a spread sheet application that has limitations. Also, check [Include Time Axis Information] if you need time axis data.

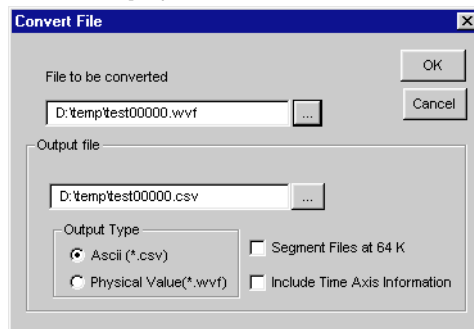

Example in which the data converted to ASCII data is opened with Microsoft Excel

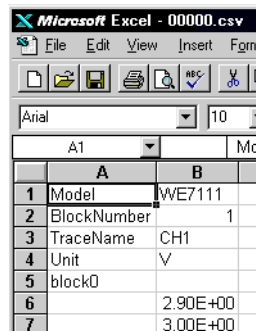

4.9 Assorted Module Binding Function

This section describes the assorted module binding function that allows waveforms of different types of modules to be combined and displayed on a single monitor and measured data to be saved to a single file.

Limitations

The following limitations exist in the assorted module binding function.

- Recommended PC and memory: Pentium II 400 MHz or higher*, 128 MB or more
 - * Depending on which combination of modules are used, the WE7000 may not operate properly unless the PC's processor exceeds this speed.
- Applicable modules: WE7081, WE7231 (Ver. 3.05 or later), WE7235, WE7241, WE7245, WE7251, WE7271/WE7272/WE7273, WE7275, and WE7521 (Ver. 3.03 or later) within the same measuring station.
- Only ten types from the above modules are selectable.
- Only a single Waveform Monitor can display waveforms of bound modules.
- Acquisition mode of the applicable module: Select trigger mode or free run mode for all applicable modules.
(If you select trigger mode, WE7231 and WE7241 is not applicable.)
- Waveform data of a module with a long sampling interval when the sampling interval is different: Pulse interpolation is performed on the deficient data.
- Time base: Select internal or external clock for all applicable modules.
- Modules that are specified for the assorted module binding function cannot display the Waveform Monitor or save the measured data by itself. In addition, the operation panel can be opened, but some items cannot be specified.
- The digitizer modules (WE7251/WE7271/WE7272/WE7273/WE7275), the strain module (WE7245), and the timing measurement module (WE7521) can increase the maximum record length by reducing the number of the measurement channels. However, this function cannot be used during assorted module binding. In addition, the function that enables you to specify a 1-kHz input filter on the WE7251 Digitizer Module cannot be used during assorted module binding.
- The WE7521's time stamp mode cannot be used.
- The WE7521's data hold setting will be set to ON.

Setting the Assorted Module Binding

1. Start the WE7000 Control Software.
2. From the [Tools] menu, choose [Assorted Module Binding] > [Setup].

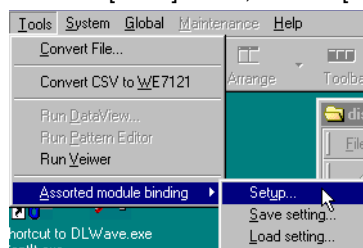

- In the dialog box below, select the acquisition mode and the target modules and click [OK].
If multiple measuring stations are connected, click the target measuring station in the Station box before selecting the modules.

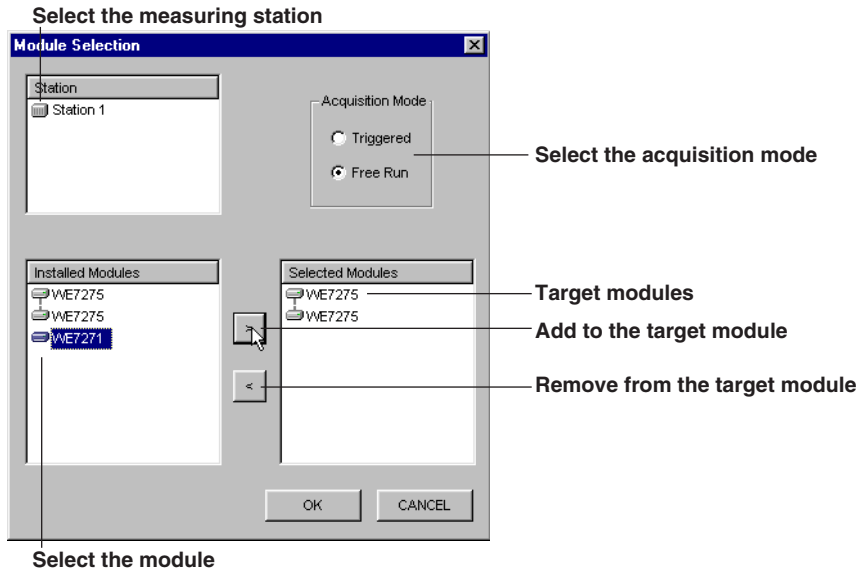

- On the Bound Module operation panel that appears, select common measurement conditions such as the sampling interval and time base.

When in Free Run Mode

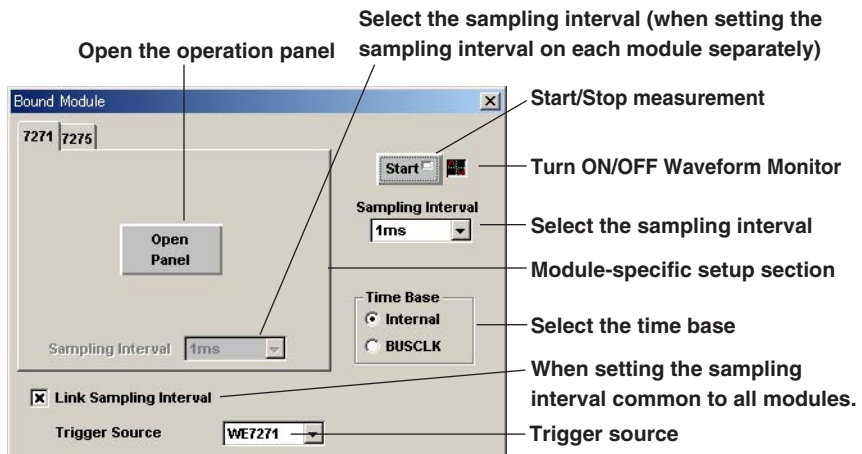

- Sampling Interval**
To use the same sampling interval on both modules for making measurements, select the [Link Sampling Interval] check box and choose the sampling interval from the [Sampling Interval] list box. However, the actual interval used by the module for making measurements is the sampling interval corresponding to the specification of each module. If a sampling interval that does not exist in the specifications of one module is selected, the data over the interval in which measurements are not made is interpolated using the previous value. To specify the sampling interval for each module separately, clear the [Link Sampling Interval] check box and select the interval using the [Sampling Interval] list box in the module-specific setup section. The maximum allowable difference of sampling intervals between the modules is 1000 times.
- Time Base**
If you selected the external clock (BUSCLK), you must select the time base source (CMNCLK) in the trigger source/time base source/arming setting dialog box that appears by clicking the Trigger button on the menu bar.

- **Trigger Source**
Select the trigger source used to control the waveform data save operation using triggers or gates from the [Trigger Source] list box. The selectable trigger source are the trigger outputs of either module or bus trigger BUSTRG.
- **Setting the Measurement Conditions on Each Module**
Click [Open Panel] in the module-specific setup section and set the conditions using the displayed operation panel. The items that cannot be specified during assorted module binding are shaded. In addition, you cannot change the settings while measurement is in progress. Clicking Start on the Bound Module operation panel closes the panel.
- **Precautions to be taken during operation**
 - The start of measurement may be offset by up to 60 ms between modules.
 - If the time base is set to external clock (BUSCLK), set the period of the external clock according to the specifications of the module that is to use the external clock.
 - If the time base is set to Internal, displayed data from the WE7231 Fast Digital Thermometer Module or WE7521 Timing Measurement Module may be erroneous by up to 0.8 s/h along the time axis relative to the other bound modules. Please be aware of this when performing continuous measurement in Free Run mode.

When in Trigger Mode

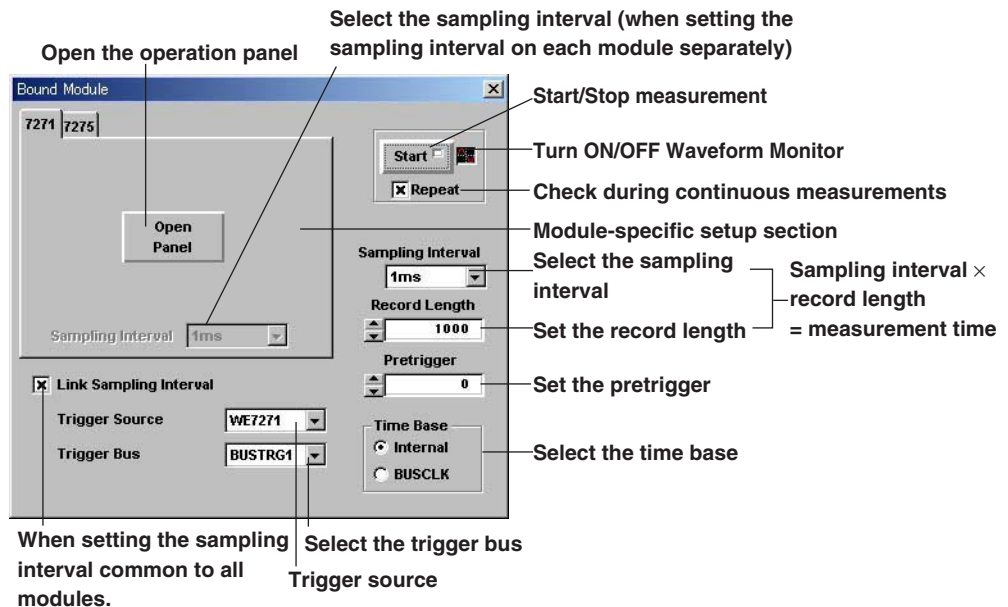

- **Sampling Interval**
To use the same sampling interval on both modules for making measurements, select the [Link Sampling Interval] check box and choose the sampling interval from the [Sampling Interval] list box. If a sampling interval that does not exist in the specifications of one module is selected, the data over the interval in which measurements are not made is interpolated using the previous value. To specify the sampling interval for each module separately, clear the [Link Sampling Interval] check box and select the interval using the [Sampling Interval] list box in the module-specific setup section. The maximum allowable difference of sampling intervals between the modules is 100 times.
- **Time Base**
If you selected the external clock (BUSCLK), you must select the time base source (CMNCLK) in the trigger source/time base source/armring setting dialog box that appears by clicking the Trigger button on the menu bar.
- **Trigger source**
Select the trigger source from the [Trigger Source] list box. The selectable trigger sources are the trigger outputs of either module or bus trigger (BUSTRG).

- **Trigger Bus**
 Since the same trigger signal is used by the target modules through this function, either the BUSTRG1 or BUSTRG2 trigger bus is occupied by this function. The manual trigger of the occupied trigger bus cannot be used. Use the [Trigger Bus] list box to make the selection.
 These settings are applied to the “trigger source/time base source/arming setting” at the start of the measurement. If the trigger source is not BUSTRG and if a module that is not a target module of the assorted module binding is outputting the trigger signal to the trigger bus, the setting is made invalid at the start of measurement. In this case, the settings are not set back even if you stop the measurement.
- **Record length**
 The selectable record length varies depending on the selectable sampling intervals of the target modules as following below. And even at the ranges shown below, it is only possible to set a record length such that data can be acquired at a measurement interval of 5 ms or more.
 WE7251: 100 to 100 k points, WE7245/WE7271/WE7272/WE7273/WE7521: 100 to 1 M points, WE7081/WE7275: 100 to 2 M points
- **Pretrigger**
 The selectable range of pretrigger varies depending on the specified sampling interval and record length.
- **Setting the Measurement Conditions on Each Module**
 Click [Open Panel] in the module-specific setup section and set the conditions using the displayed operation panel. The items that cannot be specified during assorted module binding are shaded. In addition, you cannot change the settings while measurement is in progress. Clicking Start on the Bound Module operation panel closes the panel.

5. Click [Start].

Displaying the Station List Window After Setting Assorted Module Binding

After carrying out the above step, the Bound Module operation panel opens and, at the same time, the Bound Module icon appears in the station list window. When this icon appears, you can double-click it to open the Bound Module operation panel.

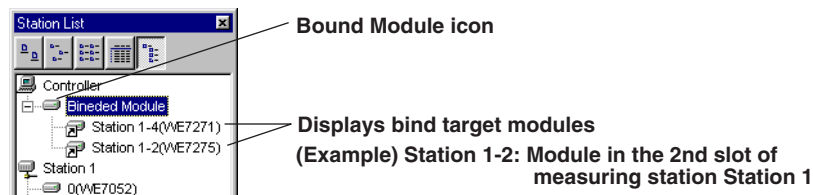

Right-clicking the Bound Module icon displays the following pop-up menu.

To change the combination of the target modules, select [Unload] on this menu. With this operation, the Bound Module icon disappears and you will be able to select the target modules by choosing [Assorted Module Binding] > [Setup] from the [Tools] menu. Carry out similar steps to change the acquisition mode. The commands other than Unload on this menu can be used to carry out operations that are similar to the pop-up menu of normal module icons.

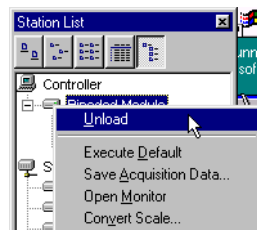

Displaying the Bound Module Waveform Monitor

When you click Start on the Bound Module operation panel, a Waveform Monitor similar to a normal Waveform Monitor opens. As shown below, module identification numbers (the “xxxx” section of “WExxxx”) are displayed in the scale display and other displays.

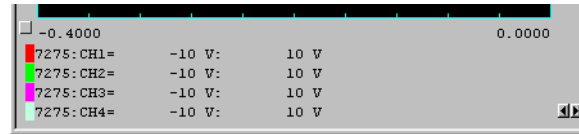

Saving and Loading Bound Module Setup Data

You can save the target modules and acquisition mode; settings in the Bound Module operation panel; and the Waveform Monitor settings of the Assorted Module Binding function to a file and load the settings to immediately start the Bound Module Waveform Monitor.

To save the setup data, choose [Assorted Module Binding] > [Save setting] from the [Tools] menu. The Save As dialog box appears. Specify the save destination directory and file name (.wsl extension is automatically added) and click [Save].

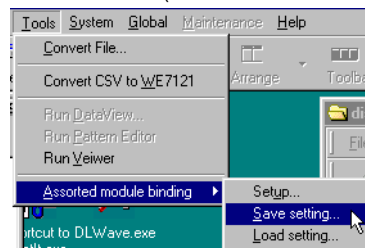

To load the setup data, choose [Assorted Module Binding] > [Load] setting from the [Tools] menu. The [Open] dialog box appears. Select the setup data to be loaded and click [Open].

Note

The assorted module binding information is also included in the setup data file of the WE Control Software (.wes extension).

5.1 Troubleshooting

- If servicing is necessary, or if the instrument is not operating correctly after performing the following corrective actions, contact your nearest YOKOGAWA dealer.

Problem	Possible Cause/Corrective Action	Reference
The main power switch on the back panel of the measuring station is ON, but the standby power switch does not turn ON.	Firmly plug in the power cord and turn on the standby power switch on the front panel. If you are using the WE900, check that the circuit breaker on the back panel is ON. If the standby switch still does not turn ON, the measuring station may have malfunctioned (abnormal power supply, fuse is blown, and etc.).	2-9 to 2-11
Buzzer sounds are heard intermittently and the measuring station automatically enters the standby condition (modules stop operating).	Cooling fan has stopped. Repair is necessary.	2-11, 4-2
On the WE800, a module operates properly when installed to slots 0 to 4, but does not operate when installed to slots 5 to 8.	One of the two power supply units has malfunctioned. Repair is necessary.	2-10
Cannot perform Ethernet communication with the measuring station.	If the power status LED of the measuring station is not illuminated, check that the power cord is securely connected and that the main power switch on the rear panel of the measuring station is ON. Check to see that the Ethernet interface on the PC is operating properly. If the power status LED of the measuring station is illuminated, check whether the "LINK" LED of the UTP connector is illuminated. If it is not lit, check that the UTP cable is connected securely to the UTP connector as well as to the hub. Also, check whether the hub's power is turned ON. If it is lit, check whether the "TX-RX" LED of the UTP connector blinks when the WE7000 Control Software is started. If it does not blink, check to see that the Ethernet cable connection between the measuring station and the PC is correct. If the connection is correct, connect the PC to the measuring station using USB communication and check whether the IP address, subnet mask, default gateway, port number, and group number settings on the measuring station are correct. Furthermore, open the properties of the [WE7000] shortcut icon for Ethernet communication and check that the port number and group number settings are the same.	2-8, 2-10, 2-11, 3-12, 3-13, 3-14
Communication is not possible through the optical fiber cable or it is unstable.	If the "STANDBY" LED on the optical interface module is not lit, check to see that the power cord is plugged in correctly, that the main power switch is turned ON, and that the optical interface module is connected securely to the slot. If the "STANDBY" LED is lit, check whether the "Port 1" LED or the "Port 2" LED on the optical interface module is lit. If the LED of the port you are using is not lit, check to see that the optical fiber cable is connected securely to the optical interface module as well as to the optical interface card. If the cable connection is fine, the cable may be damaged, the optical fiber connector may be damaged, or the optical fiber connector end may be dirty. If the "Port 1" LED or the "Port 2" LED is blinking when there is no data transfer, perform a similar check.	2-6, 2-10
"STATUS" LED on the optical interface module stays lit	If the "STATUS" LED stays lit for 10 seconds and then turns off, optical interface is temporarily suspended because the re is too much load on the network. If it stays lit for a longer period of time, it is probably due to a malfunction.	1-3
Signal cannot be input or output through the external input/output connector (EXT I/O).	Check whether the input/output switch setting between the external input/output terminal and trigger source is correct in the trigger source/time base source/Arming setting dialog box that is displayed by selecting [Station] - [Trigger Setting] in the station window.	4-22, 4-23
Station icon does not appear in the main window.	Check the optical fiber cable connection. Check the cable connection and the interface settings, when connecting to USB or Ethernet.	2-6, *
Cannot turn ON/OFF the standby power switch from the PC.	This operation is not available if you are communicating through the serial interface.	4-1, *

5.1 Troubleshooting

Problem	Possible Cause/Corrective Action	Reference
Station window does not appear even when the station icon is double clicked.	<p>If you are using serial interface, check to see that the cable is connected correctly. Also check that the standby power switch is turned ON. This condition also occurs if the baud rate or hardware handshaking is incorrect or if the wiring of the optical fiber cable is incorrect.</p> <p>If you are connecting the measuring station and PC via the Ethernet network, select Refresh from the View menu.</p>	2-8, 2-10, 3-5 4-9
Updating of the displayed waveform stops when the waveform monitor window is clicked.	<p>If you are using the following software application, the default setting at installation is set to display the content of the window when dragged.</p> <ul style="list-style-type: none"> • When using Internet Explorer 4.0 Remove the check from the item which allows dragging of the window with the content being displayed in the graphics setting of the [Start Menu] - [Setting] - [Folder and Icon] display tab. • When using Plus Remove the check from the item which allows dragging of the window with the content being displayed in [My Computer] - [Control Panel] - [Screen] Plus! tab. 	—
"Invalid Module" is shown in the title bar of the module operation panel, and the module cannot be operated.	<p>Right-click the station icon and choose [Properties]. In the dialog box that opens, check that the module software version is appropriate. The module software version that can be used on the WE500/WE900 is 5.01 or higher (excluding WE7081 and WE7262).</p> <p>If the module software version is appropriate or if the module name shown in Properties is not correct, the module is likely to have malfunctioned.</p> <p>If the module software version less than version 5.01, the software must be upgraded.</p>	1-3, 4-15
When you open the module setup panel, a message "[!] You can not use this Module because of software problem...." appears, and you cannot control the module.	<p>The module firmware version may be old.</p> <p>Check whether the module software is of an appropriate version by right-clicking the station icon and choosing Properties.</p> <p>If the module software version less than version 5.01 (excluding the WE7081 and WE7262), the software must be upgraded.</p> <p>For the procedure of updating the module software, contact your nearest YOKOGAWA dealer.</p>	2, 1-3, 4-16

* See the user's manual that came with the optical interface card or module.

5.2 Self Test

If you believe the module is behaving abnormally, perform the self test according to the following steps.

Starting Self Test

1. Change the input/output connection of the module according to the instructions given in the “Self Test” section of the User’s Manual for the module.

Example: For WE7111, connect the probe to the measurement input terminal and connect the tip to the CAL output terminal.

2. Select [Self Test] from the [System] menu of the menu bar.



3. In the [Self Test] dialog box that appears, select the station name and enter the slot number. Then, click the [Execute] button.

“Executing...” is displayed in the result display box.

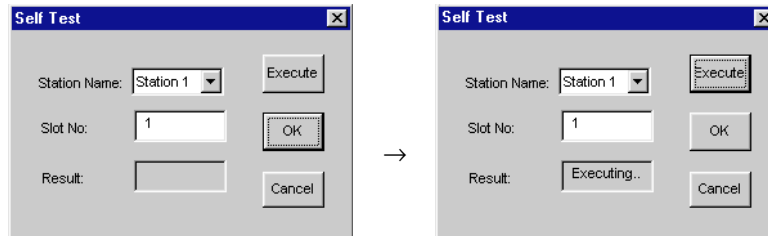

Note

If you wish to self test the measuring station, set the slot number to “-1.” If you wish to self test the optical interface module, set the slot number to “0.”

Verifying the Test Result

If a value other than “0” is displayed in the “Result” display box of the “Self Test” dialog box, the module probably has malfunctioned. Please contact your nearest YOKOGAWA dealer.

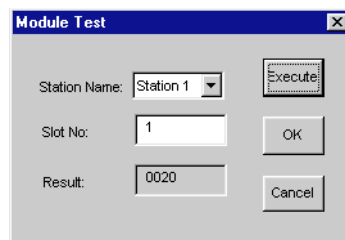

5.3 Maintenance

Replacement of Parts

Cooling fan and power supply need to be replaced periodically.

The general guideline for replacement is as follows. Please contact your nearest YOKOGAWA dealer in replacing the parts.

- Power Supply Unit
2 years on 24-hour continuous operation
- Fan
1 year on 24-hour continuous operation

Replacing a Fuse

There is a fuse inside the measuring station. However, you should not replace the fuse yourself. If you believe the fuse is blown, please contact your nearest YOKOGAWA dealer.

Fuse Rating

Measuring Station	Location	Rated Voltage	Rated Current	Type	Standard
WE500	AC inlet board (F1)	250 V	5 A	Time lag	VDE, BSI, SEMKO, UL
WE900	AC filter board (F1, F2)	250 V	5 A	Time lag	VDE, BSI, SEMKO, UL
WE500/WE900	Sub power supply A1588UP (F11)	250 V	3 A	Time lag	UL, CSA

Circuit Breaker

There is a circuit breaker on the rear side of the measuring station WE800. If abnormal conditions are detected in the internal circuit, the circuit breaker will shut down the power supply. In this case, you can recover the previous condition by pressing the reset button one minute after the shutdown. If the reset button does not return to the original position, the WE800 has malfunctioned. Do not reset the measuring station repeatedly. Contact your nearest YOKOGAWA dealer.

Calibration of Measurement Modules

We recommend that you calibrate the measurement module once a year to assure the accuracy of its measurements. Please contact your nearest YOKOGAWA dealer to have the module calibrated.

6.1 Specifications of the Measuring Station

Number of Slots

WE500: 5
WE900: 9

Bus

WE Bus (Yokogawa proprietary bus)

Trigger/Time Base (within WE Bus)

Trigger

Trigger source: TRIG input, communication, measurement module, EXT. I/O input
Number of bus triggers: 2 (BUSTRG1/BUSTRG2)

Time base

Time base source: TRIG input, communication, measurement module, EXT. I/O input
Number of time base: 1 (CMNCLK)

Signal Input/Output

TRIG

Connector type: BNC
Pulse width: 100 ns or more (or 50 ms or more as an arming source)
Detection level: High active/Low active
Input impedance: Approx. 47 k Ω
Input level: CMOS level
Maximum allowable input voltage: -3 V to +8 V (Overvoltage Category CAT I and II)
* Able to connect to bus trigger (BUSTRG1/BUSTRG2) or time base (CMNCLK)

EXT. I/O

Connector type: 15-pin D-sub type (female)
Input/output level: CMOS level
Trigger input/output: Bus trigger (BUSTRG1/BUSTRG2) and common (switch input and output)
Input impedance: Approx. 47 k Ω
Input pulse: 100 ns or more
Maximum input frequency: 5 MHz
Maximum allowable input voltage: -3 V to +8 V (Overvoltage Category CAT I and II)
Output impedance: Approx. 100 Ω
Maximum output current: ± 3.2 mA
Time base input/output: Common clock (CMNCLK) and common (switch input/output, rising edge active)
Input impedance: Approx. 47 k Ω
Input pulse: 100 ns or more
Maximum input frequency: 5 MHz
Maximum allowable input voltage: -3 V to +8 V (Overvoltage CAT I and II)
Output impedance: Approx. 100 Ω
Maximum output current: ± 3.2 mA
Simple DIO input/output: control output, detect input condition
Bit number: 4 bit (inside Pull Down)
Input impedance: Approx. 47 Ω
Maximum allowable input voltage: -3 V to +8 V (Overvoltage CAT I and II)
Output impedance: Approx. 100 Ω
Maximum output current: ± 3.2 mA
Bus active output: Indicates that the bus active (High level) condition
Output impedance: Approx. 100 Ω
Maximum output current: ± 3.2 mA

Communication

USB

Electrical and mechanical specifications: Conforms to USB Rev. 2.0 (When USB of PC to be used is USB1.1, it operates as an USB1.1 instrument)

Transmission speed: Maximum 480 Mbps

Port number: 1

Correspondence system environment: The model equipped with the USB port for OS of PC to be used by Windows 98 SE, Windows Me, Windows 2000, or Windows XP (a device driver is required for connection with a personal computer separately.)

Ethernet

Port number: 1

Electrical and mechanical specifications: Conforms to IEEE802.3

Transmission method: Ethernet (100BASE-TX, 10BASE-T)

Transmission speed: Maximum 100 Mbps

Communication protocol: TCP/IP

Corresponding service: DHCP client

Connector form: RJ-45 connector

Specifications of WE7000 Control Software

Turning ON/OFF the standby power on measuring station

Turn ON/OFF the standby power on the measuring station when the main power is ON.

Changing the names of controller/measuring station

Assign names to the PC (controller) and measuring stations that are connected.

Network configuration

Select whether to automatically obtain the IP address (DHCP) or use a fixed IP address during Ethernet communication.

Detecting module connection

Automatically detects modules that are installed to the measuring station.

Displaying information on measuring station/module

Displays names and model numbers of measuring stations and modules.

Displaying operation panels of each measurement module and controlling measurement operation

- Reads data from the flash memory of each measurement module, and displays the operation panel.
- Transmits information set at the operation panel to each of the measurement modules in realtime.
- Saves information set at the operation panel to the hard disk of a PC. Also, loads the saved information.

Trigger source/Time base source/Arming setting

- Sets which measurement module from which to input the trigger/clock signal; from the external input/output connector or the external trigger input connector of the measuring station.
- Sets the input and output of the arming signal that allows multiple measurement modules to start their measurements simultaneously.
- Sets which measurement module to input the trigger/clock signals generated by each of the measurement modules.
- Sets synchronization across same type of modules
- Generates the manual trigger signal.
- Sets external output of trigger/time base signal

Assorted module binding

Combine different types of modules and display the waveforms on a single monitor or save the waveform data to a single file.

Displaying measured data

Displays the measured data of each module in the appropriate form in the operation panel or waveform monitor.

Saving/Loading measurement data

- Saves the measured data of each module in the appropriate form
- Control the start and stop times for saving data by specifying the time or using triggers
- Loads and displays the saved data on viewer

Converting saved data

Converts saved data to text data in CSV format or to binary data in 32-bit floating format (IEEE 754-1985).

Saving/Printing image data of a displayed waveform

- Saves image data of the displayed waveform to a BMP file.
- Copies image data of the displayed waveform to the clipboard.
- Prints the displayed waveform.

Monitoring the conditions of stations/modules

Detects the abnormal behavior of station/module and displays a message.

Web monitor function

Monitor the waveform at a remote location using a Web browser.

Help

Online help explaining the Operations/Functions in PDF file format.

General Specifications**Safety standards**

Complies with CSA C22.2 No. 1010.1 and EN61010-1, conforms to JIS C1010-1

- Overvoltage Category CAT II^{*1}
- Pollution degree 1 and 2^{*2}

*1 Overvoltage Categories define transient overvoltage levels, including impulse withstand voltage levels.

Overvoltage Category II: Applies to equipment supplied with electricity from fixed installations like a distribution board.

*2 Pollution Degree: Applies to the degree of adhesion of a solid, liquid, or gas which deteriorates withstand voltage or surface resistivity.

Pollution Degree 1: Applies to closed atmospheres (with no, or only dry, non-conductive pollution).

Pollution Degree 2: Applies to normal indoor atmospheres (with only non-conductive pollution).

EMC standards**Emission**

Complying standard

EN55011 Group 1 Class A, EN61326 Class A, AS/NZS CISPR11 Class A

EN61000-3-2

EN61000-3-3

This product is a Class A (for industrial environment) product. Operation of this product in a residential area may cause radio interference in which case the user is required to correct the interference.

Cable requirement

STP (Shielded Twisted-Pair) cable for Ethernet cable

Immunity

Complying standard

EN61326 Industrial Environment

Machine noise (for Germany)

Machine Noise information Ordinance 3. GSGV, January 18, 1991:

The sound pressure level maximum is equal or less than 70 dB(A) according to EN27779.

Maschinenlärminformationsverordnung 3. GSGV, 18.01.1991:

Der höchste Schalldruckpegel beträgt 70 dB(A) oder weniger gemäß EN27779.

Standard operating conditions

Ambient temperature: 23 ±2°C

Ambient humidity: 50 ±10% RH

Power voltage and frequency fluctuation: 1% or less of the ratings

6.1 Specifications of the Measuring Station

Operating conditions

Temperature: 5 to 40°C

Humidity: 20 to 80% RH (except maximum wet bulb temperature of 29°C, no condensation)

Storage conditions

Temperature: -20 to 60°C

Humidity: 20 to 80% RH

Operating altitude

2000 m or below

Storage altitude

3000 m or below

Rated supply voltage

100 to 120 VAC/200 to 240 VAC (auto switching)

Permitted supply voltage range

90 to 132 VAC/180 to 264 VAC

Rated supply voltage frequency

50/60 Hz

Permitted supply voltage frequency

48 to 63 Hz

Maximum power consumption^{*1}

WE500

No modules installed: 160 VA

Maximum load: 370 VA

WE900

No modules installed: 200 VA

Maximum load: 570 VA

High frequency current from power supply

Conforms to IEC1000-3-2

External dimensions

WE500: Approx. 213(W) × 266(H) × 360(D) mm (projections excluded)

WE900: Approx. 350(W) × 266(H) × 360(D) mm (projections excluded)

Weight

WE500: Approx. 6.5 kg (modules excluded)

WE900: Approx. 11 kg (modules excluded)

Cooling method

Forced air cooling

Installation position

Horizontal

Accessories

Power cord (1)

WE7000 Control Software Setup Disk^{*2} (1 CD-ROM)

USB cable (2 m, conforming to USB 2.0, A type-B type) (1)

15-pin D-sub connector (male) for connecting to EXT. I/O

Cover plates (WE500: 5 plates, WE900: 9 plates)

User's Manual (this manual) (1)

Optional accessories

707861-J6 Rack mount bracket (for single WE500, complies with JIS)

707861-E6 Rack mount bracket (for single WE500, complies with ANSI/EIA)

707862-J6 Rack mount bracket (for multiple WE500, complies with JIS)

707862-E6 Rack mount bracket (for multiple WE500, complies with ANSI/EIA)

707863-J6 Rack mount bracket (for single WE900, complies with JIS)

707863-E6 Rack mount bracket (for single WE900, complies with ANSI/EIA)

Spare parts

A1519JD/A8060KA D-sub connector for EXT I/O interface (15 pins, male)

- *1 Power consumption of the measuring station when modules are installed cannot be determined by simply summing the power consumptions of each module because the power efficiency and the power factor changes according to the load conditions as well as to the supply voltage and frequency.
- *2 System requirements of the PC for running the WE7000 Control Software
 - OS: Windows 95/98/Me, Windows NT 4.0, Windows 2000 Pro or Windows XP Professional/Home Edition
 - RAM: 128 MB or more
 - CPU: IBM-PC/AT compatible with Pentium 400 MHz or higher
 - HDD: 100 MB or more free disk space
 - When using an optical communication card (WE7035/WE7036), one or more PCI bus expansion slot (half size) is required.
 - When connecting to the Ethernet, a NIC supported by Windows 95/98/Me, Windows NT 4.0, Windows 2000 Pro or Windows XP Professional/Home Edition is required.
 - When connecting to the USB port, the PC must be running Windows 98 SE/Me, Windows 2000 Pro, or Windows XP Professional/Home Edition. A USB I/F supporting USB 1.1 and USB 2.0 and a corresponding driver are also required.

6.2 Dimensional Drawings

Unit: mm

Measuring Station (WE500: 4 Slot Model)

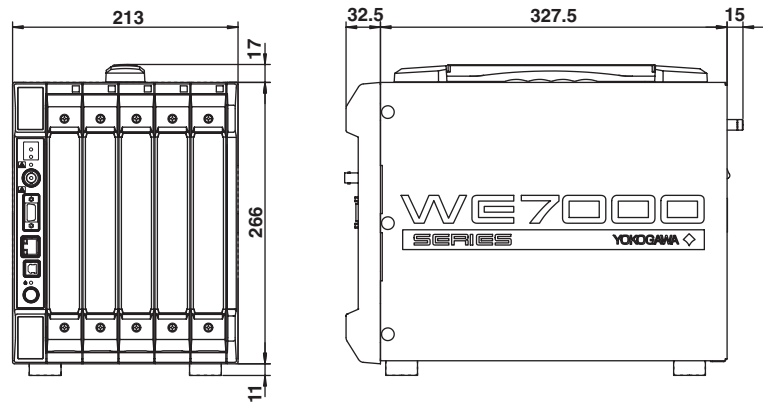

Measuring Station (WE900: 8 Slot Model)

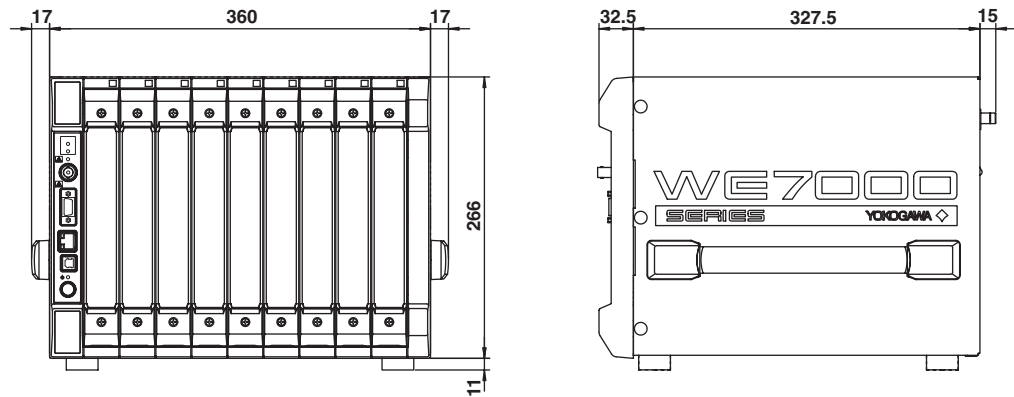

If not specified, the tolerance is $\pm 3\%$. However, in cases of less than 10 mm, the tolerance is ± 0.3 mm.

Appendix 1 Optical Interface

The measuring station capable of holding various measurement modules can be connected to the computer with an optical fiber cable allowing for the construction of a high-speed, multichannel, diversified measurement system. The optical fiber cable provides a connection that is resistive to noise. Therefore, accurate observations of phenomena at remote measuring stations are possible.

Optical Interface System Configuration

The setup data you set on the PC is transferred from the optical interface card to the optical interface module installed on the measuring station through the optical fiber cable.

Signals that enter each measurement module are processed according to the setup data and are output to the WE bus. The output signal from the measurement module is in the form specified by the information in the setup data. Then, the measured data on the WE bus is transferred to the PC through the optical fiber cable.

When using optical interface

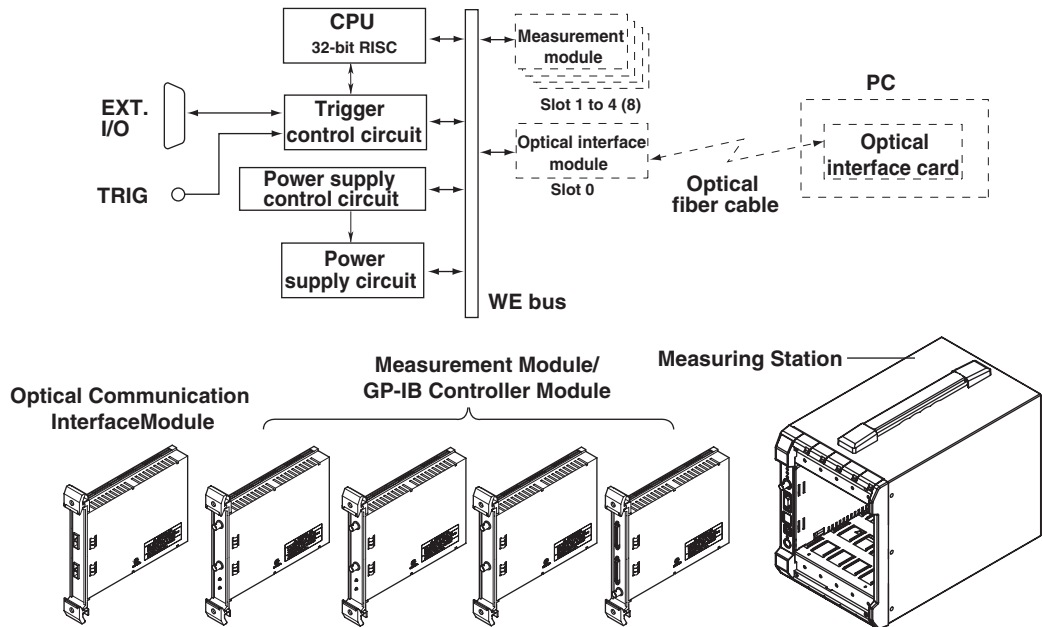

Optical Interface Card and Optical Fiber Cable

The optical interface card is a card installed in the PC that facilitates optical communication between the measuring station and computer via the optical fiber cable. The optical fiber cable used to transfer data between the measuring station and PC and between measuring stations.

Connecting the Optical Fiber Cable

When you use the optical interface, you will need one or more of the following dedicated optical fiber cables (sold separately) to connect between the measuring station and PC, or between two measuring stations. Extension connector (Model No. 707802) is available for connecting two optical fiber cables.

Name	Model	Description
Optical fiber cable	707831	Length: 2 m
Optical fiber cable	707832	Length: 5 m
Optical fiber cable	707833	Length: 10 m
Optical fiber cable	707834	Length: 1 m

Connecting the Optical Fiber Cable

Remove the port cap of the optical interface module/card and insert the optical fiber cable plug into the port. Insert the plug until it clicks and the white line is not showing. The port is not directional, so the cable can be connected to either of the two ports. You can also connect either end of the optical fiber cable to the port. When removing the plug from the port, hold the plug and pull. If you are not connecting the optical fiber cable to the optical interface module/card, keep the port covered with the port cap.

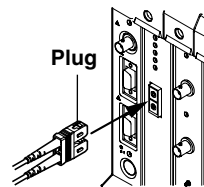

Note

For the procedures regarding the installation of the optical interface card into the PC, see the user's manual that came with the optical interface card.

Precaution for Handling Optical Fiber Cable

- Do not bend, pull, or twist the cable excessively. Be especially careful not to bend the cable under 30 mm radius.
- When pulling the cable from a wound condition, pull the cable while rotating the bundle. Make sure the radius does not fall below 60 mm in the process.
- You can use the extension connector (Model: 707802) to connect two optical fiber cables together. Use only one extension connector between the measuring station and the PC and between measuring stations. Also, the total length of the extended cable should not exceed 500 m.
- When connecting the optical fiber cable, clean the tip of the optical fiber of the plug (ferrule end) thoroughly using a gauze immersed in rubbing alcohol. If there is dirt on the ferrule end, connection loss will increase.
- If you are not using the optical fiber cable, cover the ferrule end with the accessory cap to prevent the accumulation of dirt.
- When removing the plug from the port, always pull by the plug, not the cable.
- Do not bend the cable at the base of the plug.

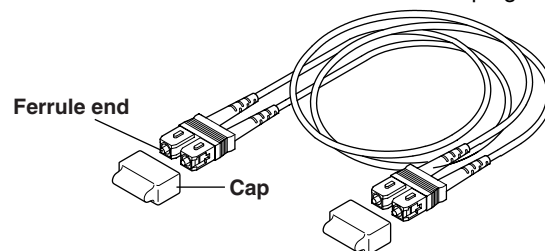

Trigger/Time Base Synchronization across Multiple Stations Using the Optical Interface Module

By installing the optical interface module into slot 0 of the measuring station, you can send trigger packet/time base packet to other stations when the bus trigger signal/time base signal changes to "True." You can also synchronize to the trigger packet/time base packet received from other stations to output the bus trigger signal/time base signal to the internal bus.

The optical interface module is designed to output a trigger packet when the bus trigger changes from "False" to "True." Therefore, when sending trigger signals to other stations through the optical interface module, only the False-to-True edge can be sent. In addition, because the two systems of bus trigger signals (BUSTRG1/BUSTRG2) are distinguished, a BUSTRG1 signal of one measuring station can only be output to a BUSTRG1 signal bus of another station. This, in turn, allows for a more diversified operation, such as sending BUSTRG1 signal from measuring station A to measuring station B while sending BUSTRG2 signal from measuring station B to measuring station A.

When using the optical interface module WE7031/WE7032, only one of the bus triggers BUSTRG1/BUSTRG2 can send trigger packets. In addition, there is a 620 μs to 700 μs delay per each station in the transfer of the bus trigger signal/time base signal. The repetition frequency of the bus trigger/time base signal is limited to 10 Hz maximum.

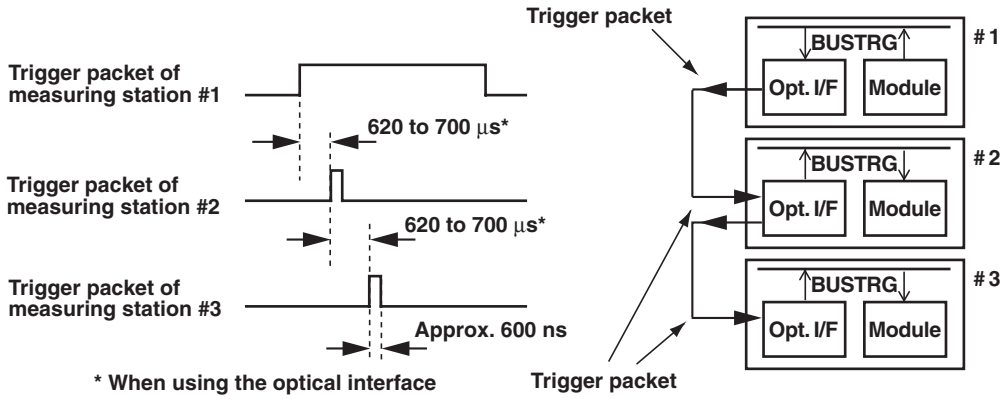

Names of Parts

Optical Interface Module

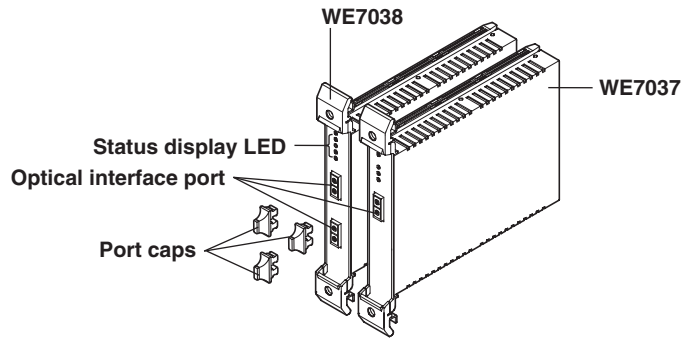

[Status display LED]
 Port1, 2 Lit: Carrier detected,
 not receiving data
 Blinking: Carrier detected,
 receive data exist
 Status Top lit: Executing command
 Bottom lit: Receive data exist
 Standby Lit: Normal operation
 (Main power switch ON)

Optical Interface Card/Optical Fiber Cable

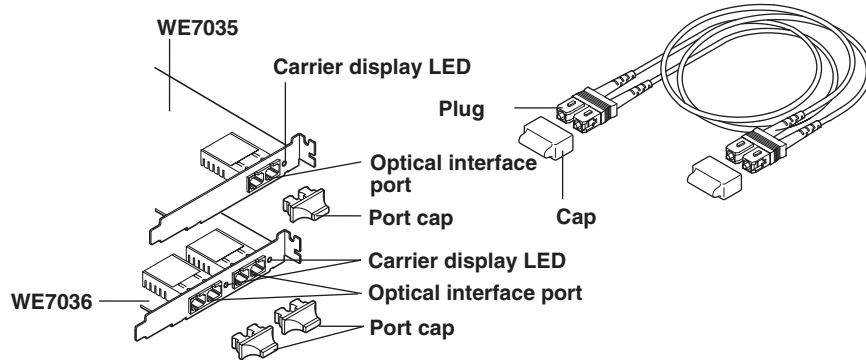

Specifications of the Optical interface Module

Number of Interface Ports

WE7037: 1 port

WE7038: 2 ports

Light-Emitting Source

1300 nm LED

Connection Method

Optical fiber with dual SC connector

Plural stations are connected in daisy chain.

Connection Fiber

Duplex multimode optical fiber with dual SC connector (graded index silica multimode optical fiber, core diameter: 50 μm or 62.5 μm , cladding diameter: 125 μm)

Transmission Rate

250 Mbps

Cable Length between Stations

500 m or less (when using fiber cable specified by YOKOGAWA)

Number of Instruments That Can Be Connected

4 units or less (includes the PC)

LED Display

Communication status, station power status display

Control Bus

WE bus

General Specifications

Safety standards

Complies with CSA C22.2 No.1010.1 EN61010-1 and EN60825-1, conforms to JIS C1010-1

- Overvoltage Category CAT II¹
- Pollution degree 1 and 2²

EMC standards

Emission

Complying standard

EN55011 Group 1 Class A

Immunity

Complying standard

EN61326 Industrial Environment

Operating conditions

Same as that of the measuring station

Storage conditions

Temperature: -20 to 60°C

Humidity: 20 to 80% RH

Power consumption

11 VA (Typical at 100 V/50 Hz³)

External dimensions

Approx. 33(W) × 243(H) × 232(D) mm (projections excluded)

Weight

Approx. 0.7 kg

Number of dedicated slots

1

Accessories

User's manual (1)

Optional accessories

707802	Extension connector (for optical fiber cable)
707831	Optical fiber cable (2 m)
707832	Optical fiber cable (5 m)
707833	Optical fiber cable (10 m)
707834	Optical fiber cable (1 m)

*1 Overvoltage Categories define transient overvoltage levels, including impulse withstand voltage levels.

Overvoltage Category I: Applies to equipment supplied with electricity from a circuit containing an overvoltage control device.

*2 Pollution Degree: Applies to the degree of adhesion of a solid, liquid, or gas which deteriorates withstand voltage or surface resistivity.

Pollution Degree 1: Applies to closed atmospheres (with no, or only dry, non-conductive pollution).

Pollution Degree 2: Applies to normal indoor atmospheres (with only non-conductive pollution).

*3 Typical values represents typical or average values. They are not strictly guaranteed.

Specifications of the Optical interface Card

Number of Interface Ports

WE7035: 1 port

WE7036: 2 port

Light-Emitting Source

1300 nm LED

Connection Method

Optical fiber with dual SC connector, plural stations are connected in daisy chain.

Connection Fiber

Duplex multimode optical fiber with dual SC connector (graded index silica multimode optical fiber, core diameter: 50 μm or 62.5 μm , cladding diameter: 125 μm)

Transmission Rate

250 Mbps

Cable Length between Stations

500 m or less (when using fiber cable specified by YOKOGAWA)

Number of Instruments That Can Be Connected

4 units or less (includes the PC)

Slot

1 PCI bus expansion slot (half size)

PC System Requirements

OS: Windows 95/98/Me, Windows NT 4.0, Windows 2000 Pro or Windows XP Professional/Home Edition

RAM: 32 MB or more (48 MB or more recommended)

CPU: IBM-PC/AT compatible with Pentium 166 MHz or higher

HDD: 20 MB or more free disk space

General Specifications

Safety standards

Complies with EN60825-1.

EMC standards

Emission

Complying standard

EN55022 Class B

Immunity

Complying standard

EN50082-1

Operating conditions

Temperature: 5 to 40°C

Humidity: 20 to 80% RH (no condensation)

Storage condition

Temperature: -20 to 60°C

Humidity: 20 to 80% RH

Current consumption

1.6 A (Typical value*)

Supply voltage

5 V \pm 10%

External dimensions

Approx. 21.6(W) \times 126.05(H) \times 187.93(D) mm (projections excluded)

Weight

Approx. 0.3 kg

Optional accessories

707802 Extension connector (for optical fiber cable), 707831 Optical fiber cable (2 m), 707832 Optical fiber cable (5 m), 707833 Optical fiber cable (10 m), 707834 Optical fiber cable (1 m)

* Typical values represents typical or average values. They are not strictly guaranteed.

Optical Interface Module (WE7037/ WE7038)

Unit: mm

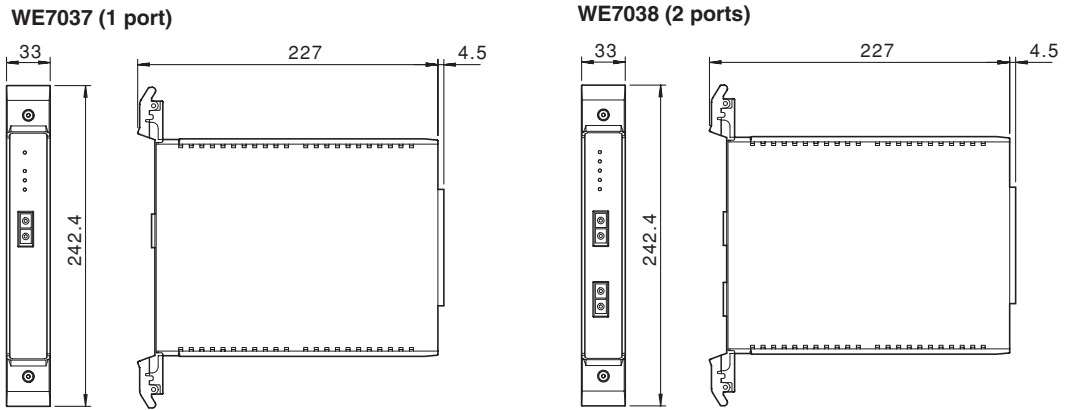

Optical Interface Card (WE7035/WE7036)

WE7035 (1 port)

WE7036 (2 ports)

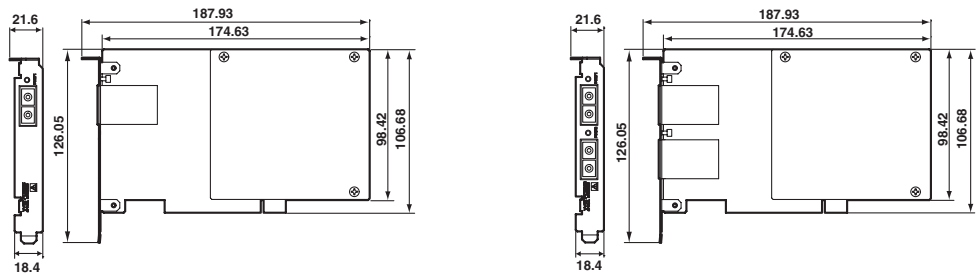

Optical Fiber Cable (70783X)

- 2m (707831)
- 5m (707832)
- 10m (707833)
- 1m (707834)

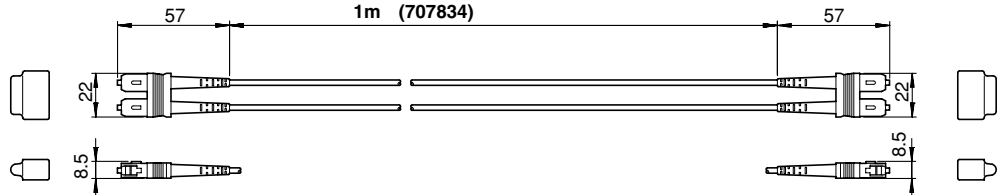

Extension Connector (707802)

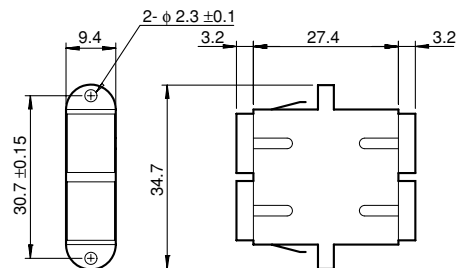

If not specified, the tolerance is $\pm 3\%$. However, in cases of less than 10 mm, the tolerance is ± 0.3 mm.

Appendix 2 Displaying Waveforms Using the Web Monitor Function

The waveforms displayed on the WE7000 Control Software can be shown on a Web browser on a separate PC over the network (Web Monitor function).

System Configuration Example

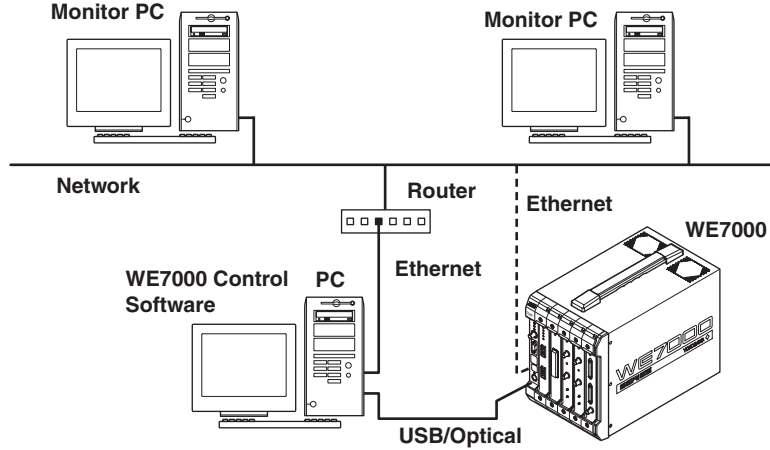

OS

One of the following OSs is required on the PC running the WE7000 Control Software to use the Web Monitor function.

Windows 2000
Windows XP Professional

Recommended Browser

Internet Explorer

Enable Java according to the following procedure.

1. From the Tools menu on Internet Explorer, choose Internet Options.
2. Click the **Custom Level** button under the Security tab.
3. Enable Active scripting under Scripting.

Preparations before Web Monitoring

To show the waveforms displayed on the WE7000 Control Software on the Web Monitor, the following software programs must be installed in the PC running the WE7000 Control Software. Be sure to install Internet Information Services (IIS) first.

- Internet Information Services(IIS)
- WEWebMonitor

Note

Before installing the software programs above, check that the OS that you are using is up-to-date. If it is not, update the OS by installing the Windows update programs provided by Microsoft.

Installing Internet Information Services (IIS)

1. Open the Windows Control Panel.

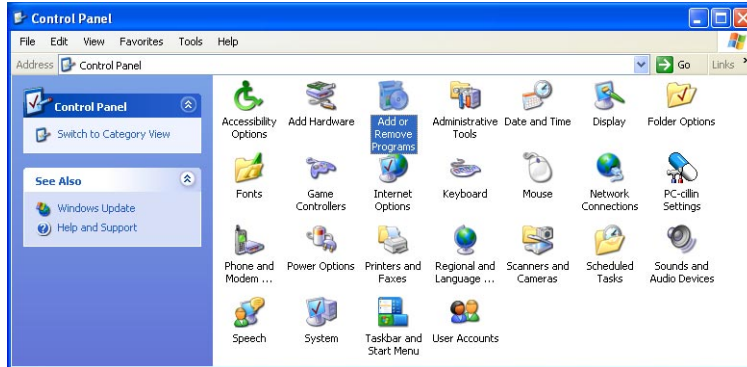

2. Double-click **Add or Remove Programs** to open the Add or Remove Programs dialog box.

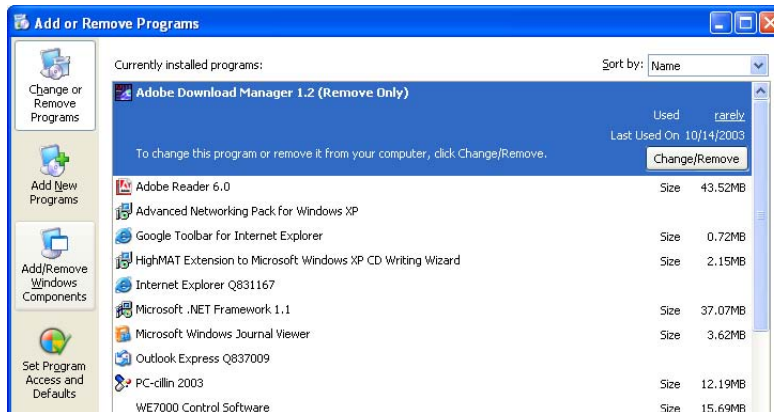

3. Click **Add/Remove Windows Components** in the left frame of the dialog box. Windows Component Wizard starts.



- Select **Internet Information Service (IIS)** and click **Details**. The Internet Information Service (IIS) dialog box opens.

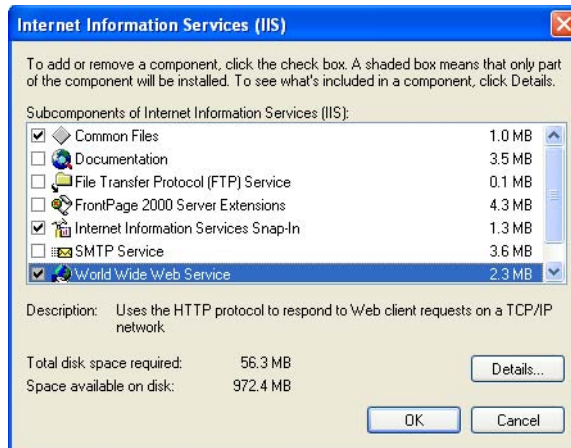

- Select the check boxes for the following three components, and click **OK**.
 - World Wide Web Service
 - Internet Information Services Snap-In
 - Common Files
 When you select the World Wide Web Service check box, the check boxes for the other two components are also automatically selected.
- Check that the Internet Information Services (IIS) check box is selected in the Windows Component Wizard, and click **Next**. The following dialog box opens.

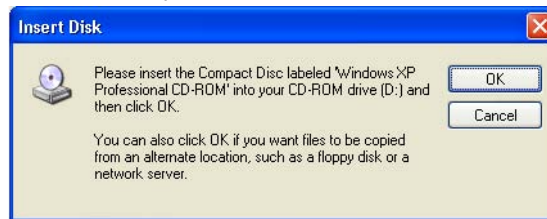

- Click **OK**. The installation starts.
- When the installation is finished, the following dialog box opens. Click **Finish** to close the installation window.



This completes the installation of Internet Information Services (IIS).

Installing the Web Monitor

Install the Web Monitor to the PC running the Control Software. The Web Monitor is provided on the WE7000 Control Software Setup Disk CD-ROM.

1. Turn ON the power to your PC.
Log on to Windows as an administrator.
2. Insert the WE7000 Control Software Setup Disk into the CD-ROM drive. The startup menu opens automatically. Select **Web Monitor** from the list box in the startup menu, and click **Install Start**.

However, if the auto run feature of the CD-ROM is disabled, start setup.exe at the root directory of the CD-ROM using My Computer or Explorer.

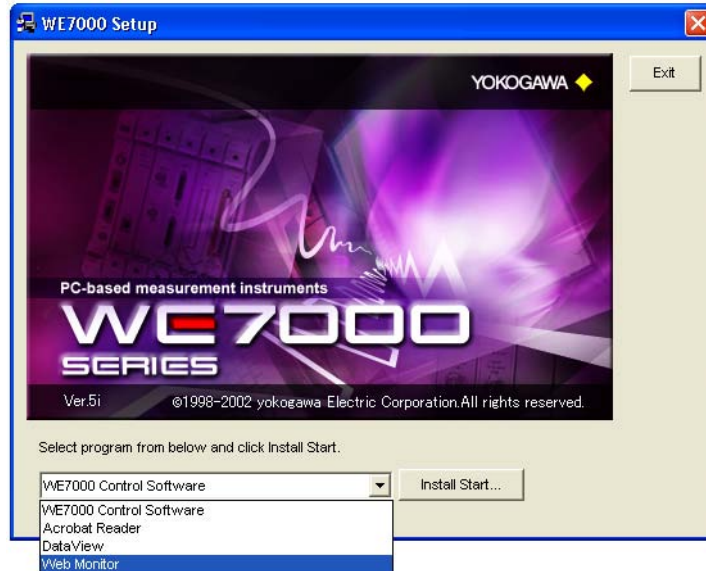

The installation starts.

The Microsoft .NET 1.1 Framework installation dialog box opens.



If the PC that you are using already has Microsoft .NET 1.1 Framework installed, the WEWebMonitor Installation Wizard window of step 5 opens. Proceed to step 6.

Note

If the PC does not have Internet Information Services (IIS) installed, a confirmation message appears. If this message appears, abort the installation, and reinstall the program according to the procedures given on page App-16.

- If Microsoft .NET 1.1 Framework is not installed, click **Yes**. The License Agreement is shown.

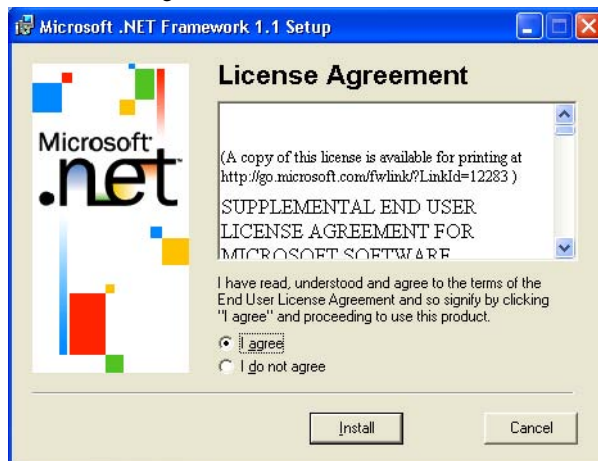

- If you agree, select **I agree** and click **Install**. The installation of Microsoft .NET 1.1 Framework starts. If you do not agree, select **I do not agree** and click **Cancel**. The installation will be cancelled.
- When the installation of Microsoft .NET 1.1 Framework is finished, the following dialog box opens.



Click **OK**. The WEWebMonitor InstallShield Wizard window opens.

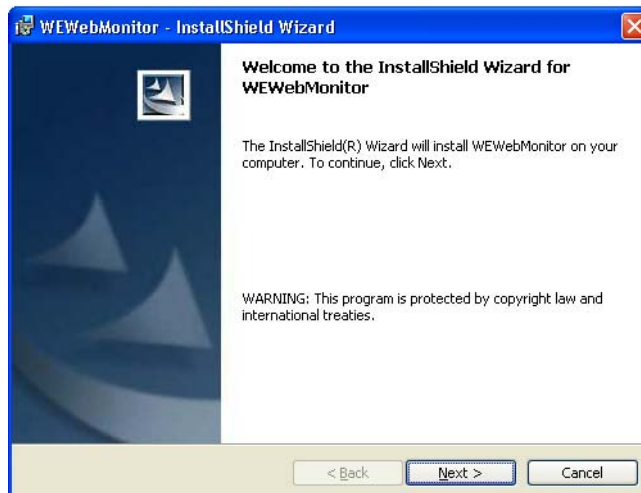

- Click **Next**. The Customer Information dialog box opens.

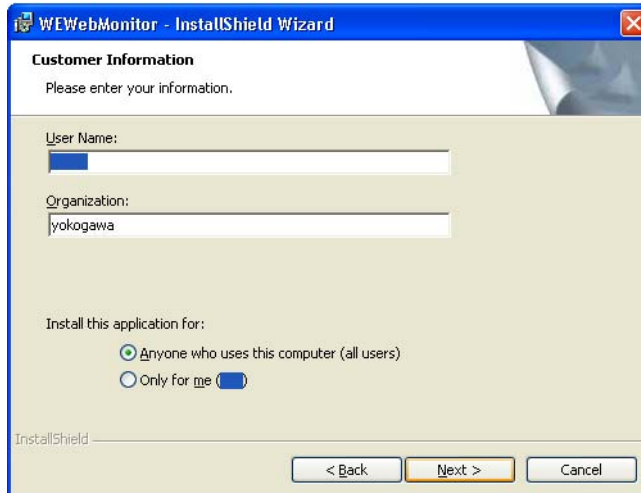

- Enter your information.
- Select whether to enable the Web Monitor for all users that log on to the PC or only for the user currently logged on, and click **Next**. The following dialog box opens.

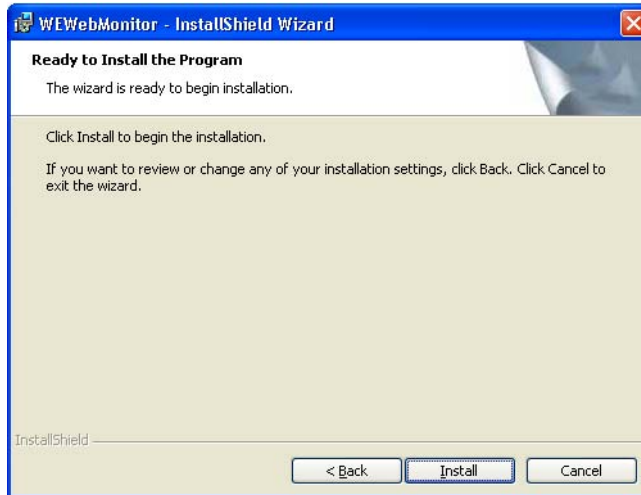

- To install the program, click **Install**. The installation starts. To not install the program, click **Cancel**. The installation will be cancelled.
- When the installation is finished, the following dialog box opens. Click **Finish** to close the installation window.



This completes the installation of the Web Monitor.

Displaying Waveforms on the Web Monitor

WE7000 Control Software

1. Start the WE7000 Control Software.
2. Select the module whose waveform is to be shown on the Web Monitor from the station list window, and right-click.

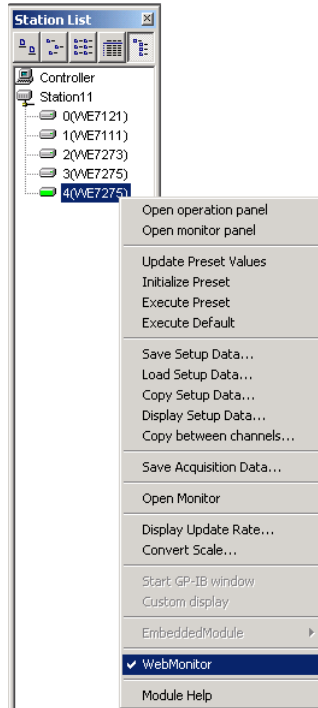

3. Check that the Web Monitor check box is selected. If it is not, click **Web Monitor** to select it.

Displaying Waveforms on the Web Monitor

1. Start the Web browser.
2. Enter "http://computer name/WEWebMonitor/WebMonitor.htm" in the Address box. The computer name is the name of the computer running the WE7000 Control Software.

The waveform Monitor displayed on the WE7000 Control Software is shown.

- Switch stations when multiple stations are being Web-monitored
- Switch the monitored module when multiple modules are being Web-monitored
- During assorted module binding
 - Bound Module:1
- Stop display updating
- Update the display repeatedly at a specified display update rate
- Update the display arbitrarily
- Display update rate
- Status of the measured data save monitor

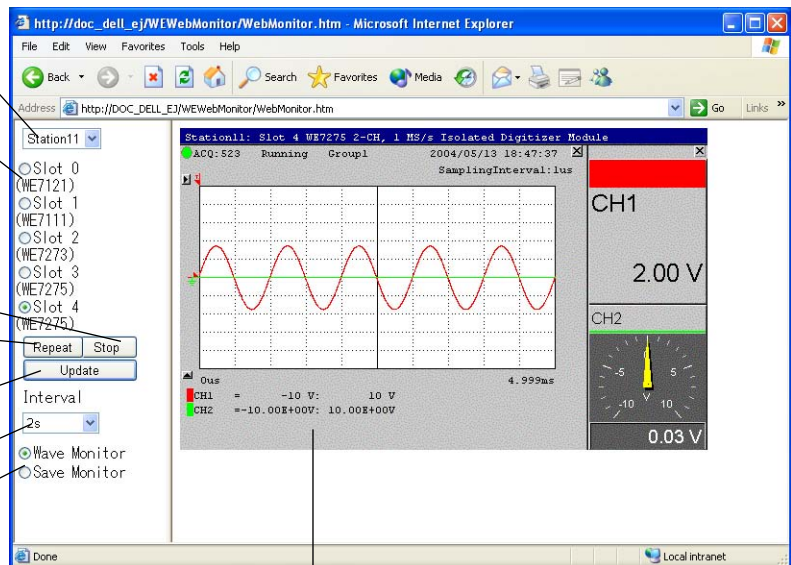

Waveform Monitor displayed on the WE7000 Control Software

If the Waveform Does Not Appear

If you install Internet Information Services (IIS) after installing WEWebMonitor, the Waveform Monitor will not be shown on the Web browser.

If this is the case, uninstall Microsoft .NET 1.1 Framework. Then, reinstall Internet Information Services (IIS) followed by WEWebMonitor.

To uninstall programs, use **Add/Remove Programs** in Windows Control Panel.

Index

Symbols

.csv	4-37
.wes	4-4
.wvf	4-4, 4-37

A

Accessories, optional	3
Accessories, standard	3
Acrobat Reader	3-7
Active module	4-22
Always on top	4-21
Arming	4-13, 4-23
Arming output destination, switching	4-24
Arming signal	1-13
Arming source	4-24
Arming, starting/stopping at once	4-23
Arrange	4-12
Assorted Module Binding Function	4-38
Auto hide	4-21

B

Bus trigger	4-24
Bus trigger signal	1-9
BUSTRG	4-24
Buzzer	2-11

C

Cascade	4-22
Cascade Panel Windows	4-7
Circuit breaker	5-4
Close	4-11, 4-22, 4-26
Close All Panel Windows	4-7
Comment	4-3
Configuration Settings	4-10
Convert CSV to WE7121	4-7
Convert Scale	4-20
Copy	4-19
Copy between channels	4-19
Create Shortcut Icons for Different Communication	3-8
Customize (buttons)	4-6
Cyclic	4-36

D

Data Viewer Pro for WE	1-6
Default	4-16, 4-18
Default.wes	4-10
Details	4-15
Display Setup Data	4-17, 4-19
Display Update Rate	4-19
Document map	7

E

Enable ARM	4-12, 4-23
Ethernet	3-9
Ethernet cable, connecting	2-8
Ethernet Communication via USB	3-13
Exit	3-16, 4-6
EXT. I/O	1-12, 2-7
External input/output connector	1-12, 2-7, 4-24

F

FAN STOP	4-2
File	4-22
File conversion	4-7, 4-37
File menu	4-4
File name	4-32
File number limit	4-36
Fuse, replacement of	5-4

G

General	4-10
Generate Bus Trigger1 Signal	4-13
Global	4-11
Group number	3-9
GUI	4-10

H

Help	3-17, 4-13
------------	------------

I

Installation conditions	2-2
Installation method	2-2
IP Address	3-9

L

Link Modules	4-24
Load Hosts File	4-9
Loading	4-17, 4-18

M

Main power switch	2-10
Main window	4-4
Manual arming	4-24
Manual trigger	4-24
Measured Data Save Operation Monitor	4-7
Measuring station	2, 1-2, 1-4
Measuring station, turning ON/OFF	4-1
Menu bar	3-15, 4-4
Module	1-3
Module icon	4-18
Monitor panel	4-18
Monitor panel, opening	4-18
Monitor/Viewer	4-7, 4-11

N

Name, changing	4-3
Network	4-8
Network Configuration	3-10

O

Open	4-4, 4-16
Open Monitor	4-19
Operation panel, opening	4-18
Optical fiber cable	App-2, App-4
Optical interface card	App-4
Optical interface module	App-4

P

Package 2
Parts, replacement of 5-4
PC-Based measurement instruments 1-1
Port number 3-9
Power OFF 4-1, 4-8, 4-11
Power ON 4-1, 4-8, 4-11
Power ON/OFF 2-10
Power supply, connecting 2-9
Power supply status LED 2-11
Preset 4-16, 4-18
Properties 4-3, 4-15, 4-16

R

Refresh 4-7
Renaming 4-3
Restarting 4-2

S

Save 4-16, 4-18, 4-31
Save Acquisition Data 4-19
Save Current Condition 4-5
Save Current Condition to Another File 4-5
Save method during free run mode 4-36
Save operation, stopping 4-36
Saving during the trigger mode/gate mode 4-36
Scale conversion 4-20
Self Test 4-11, 5-3
Set Group 4-8
Set IP 4-9
Setup data 4-16, 4-18
Sound recording method 4-35
Standby power switch 2-11
Standby power switch ON/OFF 4-1
Start 4-12
Start (Save Operation) 4-14
Start options 3-8, 3-9
Starting 3-15
Station 4-7, 4-22
Station icon 4-16
Station list window 3-15, 4-7
Station window 4-22
Stop 4-12
Stop (Save Operation) 4-14
Subnet Mask 3-9
Synchronization App-3
System 5-3

T

TCP/IP settings of the PC 3-2
Text Labels (on buttons) 4-6
Tile Horizontally 4-22
Tile Vertically 4-22
Time Base 1-9, 4-25
Time base packet 4-25
Time base signal input 4-25
Time base source 4-13, 4-23
Tool Bar 4-6
Tool button 4-4
Toolbar 4-7, 4-22
Tools 4-7
TRIG 1-11, 2-6, 4-24
Trigger input/output 4-24
Trigger input/output terminal 1-11, 2-6
Trigger output 4-24
Trigger packet 4-25
Trigger setting 4-13
Trigger source 1-9, 4-23, 4-24
Trigger/Time base signal input/output 1-10
Troubleshooting 5-1

U

USB cable, connecting 2-8
USB communication 3-13
USB driver, installing 3-4

V

View 4-6, 4-22
Viewer 4-7, 4-28
Viewer, displaying 4-7, 4-28
Voice memo 4-35

W

Waveform data, saving 4-31
Waveform monitor 4-26
Waveform monitor, closing 4-11, 4-26
Waveform monitor ON/OFF 4-36
Waveform monitor, opening 4-11, 4-26
WE Control API 1-7
WE7000 Control Software 1-5
Web Monitor Function App-9
Window 4-7, 4-22